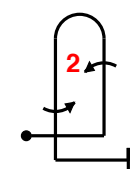
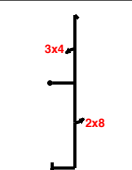
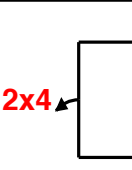
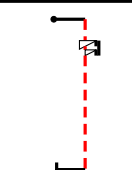
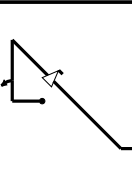
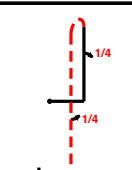
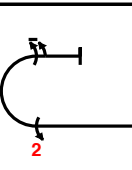
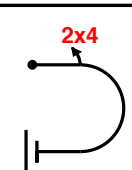

INTERNATIONAL AEROBATIC CLUB SCORESHEET

A

Contest:	Date: 2019	Category: Intermediate	Programme: Free	pilot's number	
----------	---------------	---------------------------	--------------------	-------------------	--

No	Symbol	Cat. No.	K	Total K	Grade	Remarks	Item	K	Score
1		8.4.1.1 9.2.1.4 9.1.5.4	13 13 8	34			Presentation	15	
2		5.2.1.1 9.4.1.3 9.8.5.1	17 12 3	32			FIGURE TOTAL K =		190
3		1.1.6.1 9.4.1.2	10 9	19			INC. PRESENTATION =		205
4		1.1.6.3 9.11.1.6	10 3	13			Aircraft type:		Pitts S-2B
5		1.2.6.1 9.1.1.2 9.9.4.4	14 8 11	33			FREE PROGRAM CHECKED BY:		
6		8.4.3.1 9.1.1.1 9.1.5.1	15 6 2	23			Signature:		
7		7.2.2.1 9.2.3.4 9.1.3.6	6 9 10	25			Printed Name:		
8		7.2.3.3 9.4.3.2	6 5	11			IAC No:		

Judge Name:
IAC #
Assistant Name:
IAC #



Julia Wood Pilot
 N597TJ
 A/C



B	Contest:	Category:
	Date: 2019	Program: Free
Pilot's No. 		

Pilot: Julia Wood

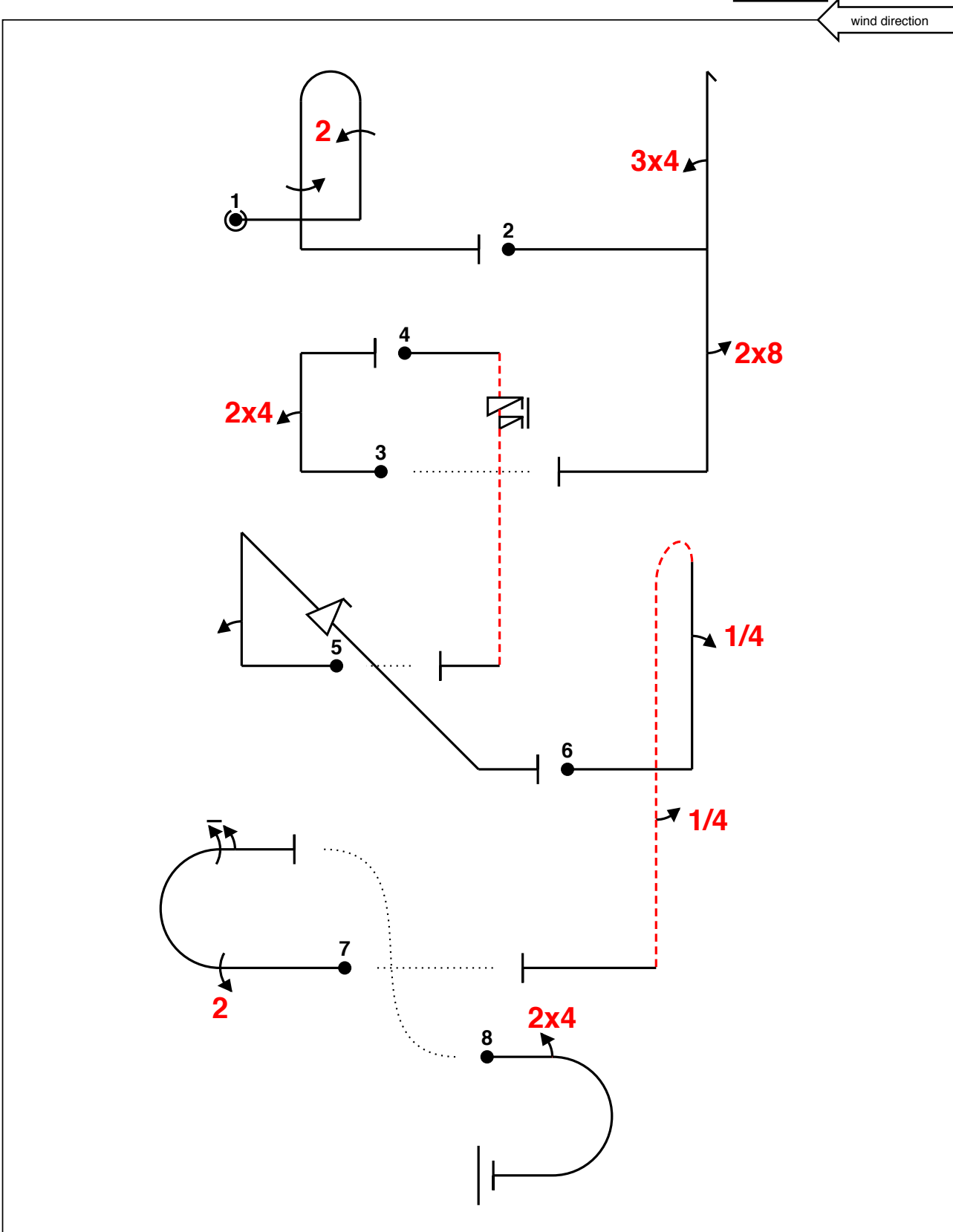

A/C: Pitts S-2B

(signature/date)

FREE PROGRAM CHECK BY:



C	Contest:	Category: Intermediate	
	Date: 2019	Program: Free	Pilot's No.

Pilot: Julia Wood

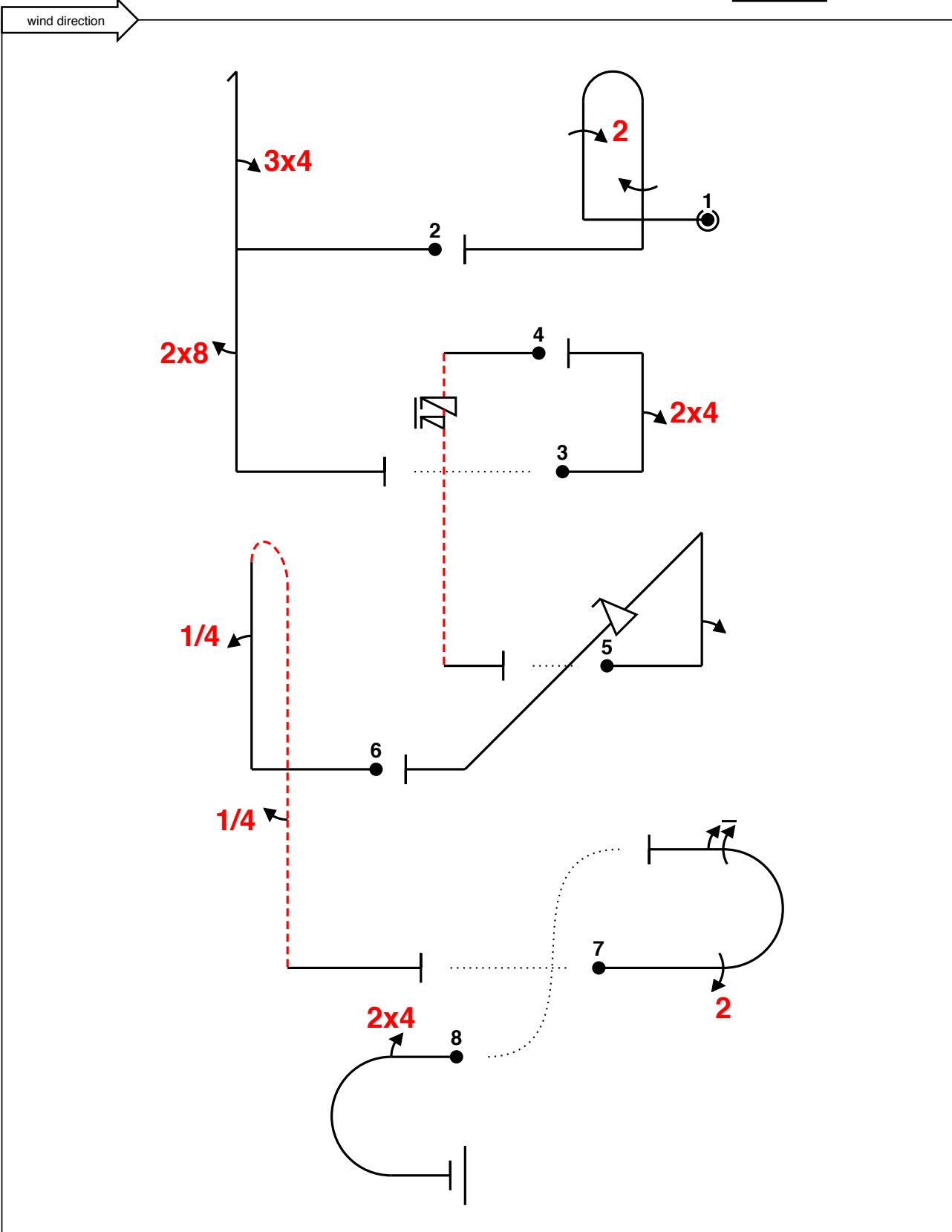

A/C: Pitts S-2B

(signature/date)

FREE PROGRAM CHECK BY:

wind direction

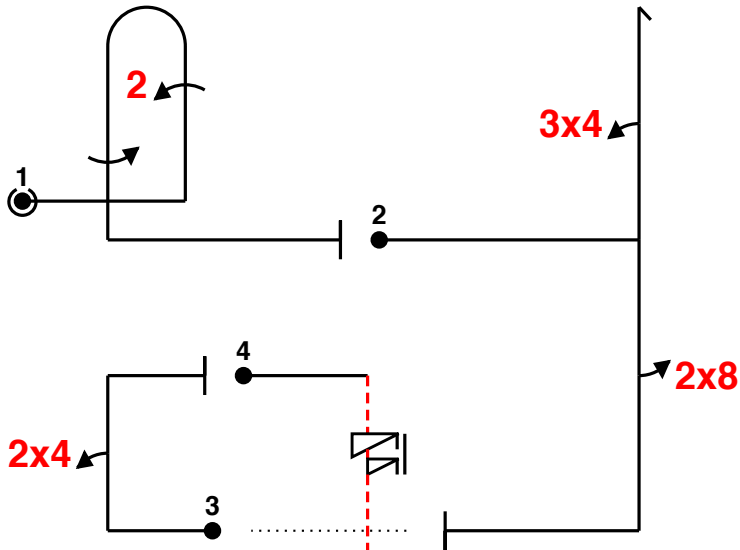

2x4

2

3x4

2x8

2

2

2x4

2

2x4

2

2

2x4

2

2x4

2

2x4

2

2x4

2

2x4

2

2x4

2

2x4

2

2x4

2

2x4

2

2x4

2

2x4

2

2x4

2

2x4

2

2x4

2

2x4

2

2x4

2

2x4

2

2x4

2

2x4

2

2x4

2

2x4

2

2x4

2

2x4

2

2x4

2

2x4

2

2x4

2

2x4

2

2x4

2

2x4

2

2x4

2

2x4

2

2x4

2

2x4

2

2x4

2

2x4

2

2x4

2

2x4

2

2x4

2

2x4

2

2x4

2

2x4

2

2x4

2

2x4

2

2x4

2

2x4

2

2x4

2

2x4

2

2x4

2

2x4

2

2x4

2

2x4

2

2x4

2

2x4

2

2x4

2

2x4

2

2x4

2

2x4

2

2x4

2

2x4

2

2x4

2

2x4

2

2x4

2

2x4

2

2x4

2

2x4

2

2x4

2

2x4

2

2x4

2

2x4

2

2x4

2

2x4

2

2x4

2

2x4

2

2x4

2

2x4

2

2x4

2

2x4

2

2x4

2

2x4

2

2x4

2

2x4

2

2x4

2

2x4

2

2x4

2

2x4

2

2x4

2

2x4

2

2x4

2

2x4

2

2x4

2

2x4

2

2x4

2

2x4

2

2x4

2

2x4

2

2x4

2

2x4

2

2x4

2

2x4

2

2x4

2

2x4

2

2x4

2

2x4

2

2x4

2

2x4

2

2x4

2

2x4

2

2x4

2

2x4

2

2x4

2

2x4

2

2x4

2

2x4

2

2x4

2

2x4

2

2x4

2

2x4

2

2x4

2

2x4

2

2x4

2

2x4

2

2x4

2

2x4

2

2x4

2

2x4

2

2x4

2

2x4

2

2x4

2

2x4

2

2x4

2

2x4

2

2x4

2

2x4

2

2x4

2

2x4

2

2x4

2

2x4

2

2x4

2

2x4

2

2x4

2

2x4

2

2x4

2

2x4

2

2x4

2

2x4

2

2x4

2

2x4

2

2x4

2

2x4

2

2x4

2

2x4

2

2x4

2

2x4

2