

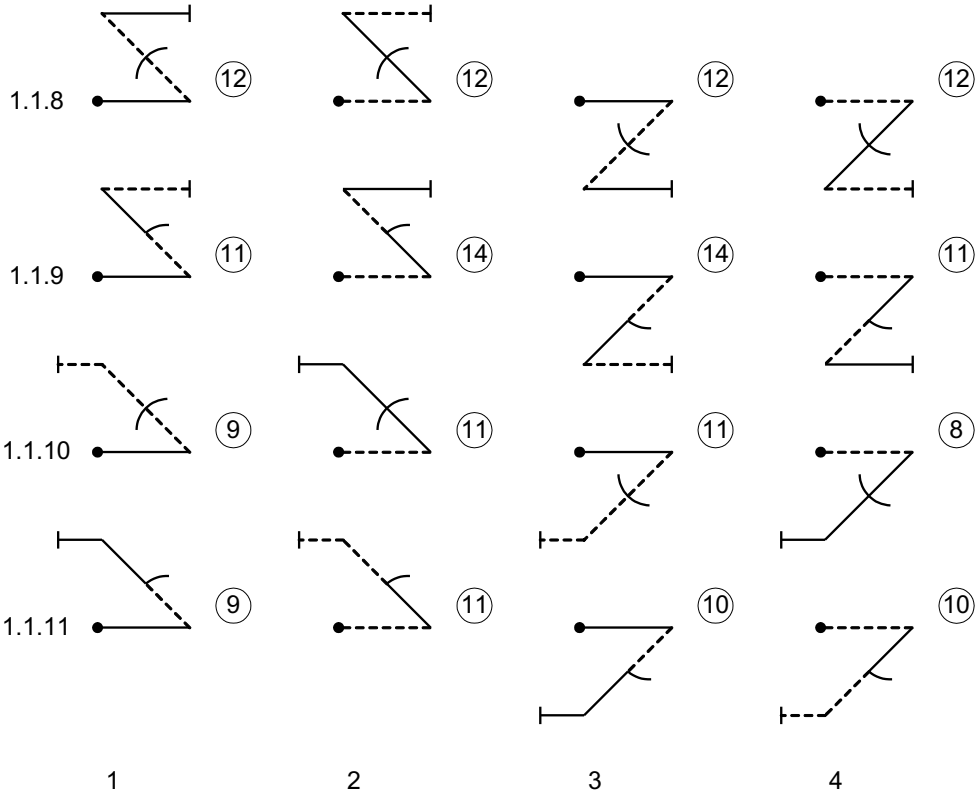

# FAMILY 1 – LINES AND ANGLES

## ARESTI AEROBATIC CATALOGUE (CONDENSED)











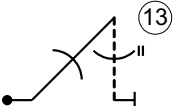
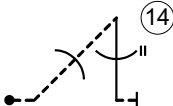
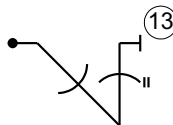
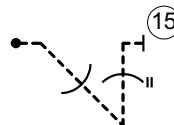
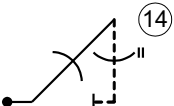
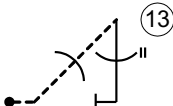
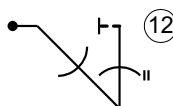
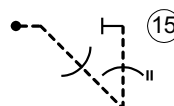
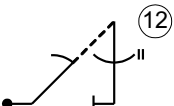

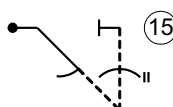
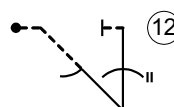
### Family 1.1. (Cont.)

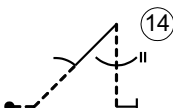
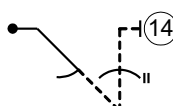
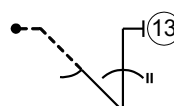

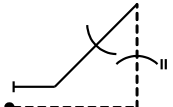
# FAMILY 1 – LINES AND ANGLES

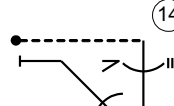
## ARESTI AEROBATIC CATALOGUE (CONDENSED)

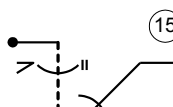
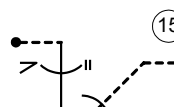
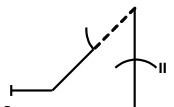
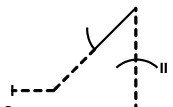
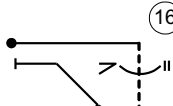

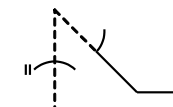
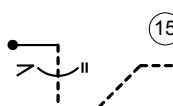
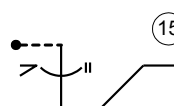

### Family 1.2. Two Lines

1.2.1				
1.2.2				
1.2.3				
1.2.4				
1.2.5				
1.2.6				
1.2.7				
1.2.8				
	1	2	3	4

# FAMILY 1 – LINES AND ANGLES

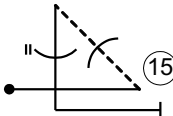
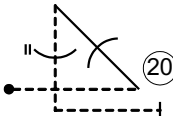
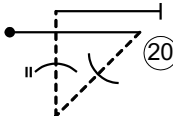
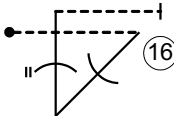
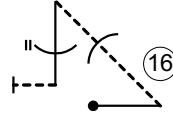
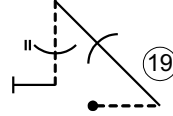
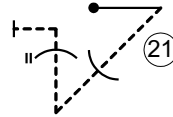
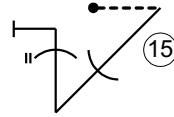
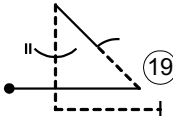
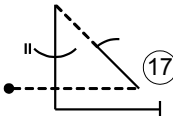
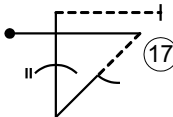
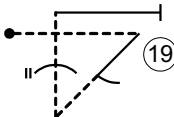
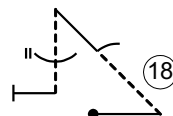
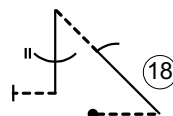
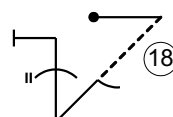
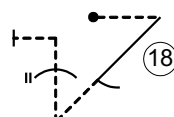
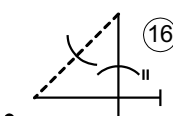
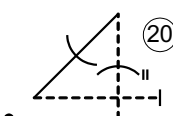
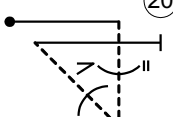
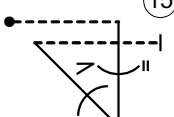
## ARESTI AEROBATIC CATALOGUE (CONDENSED)

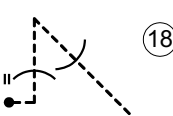
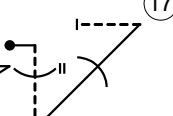
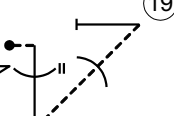
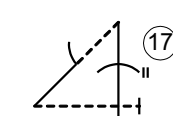
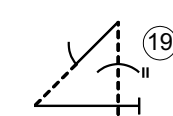
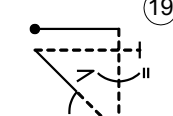
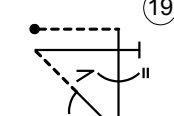
### Family 1.2. (Cont.)

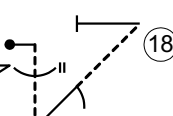
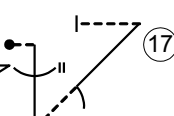
1.2.9				
1.2.10				
1.2.11				
1.2.12				
1.2.13				
1.2.14				
1.2.15				
1.2.16				
	1	2	3	4

# FAMILY 1 – LINES AND ANGLES

## ARESTI AEROBATIC CATALOGUE (CONDENSED)

### Family 1.3. Three Lines

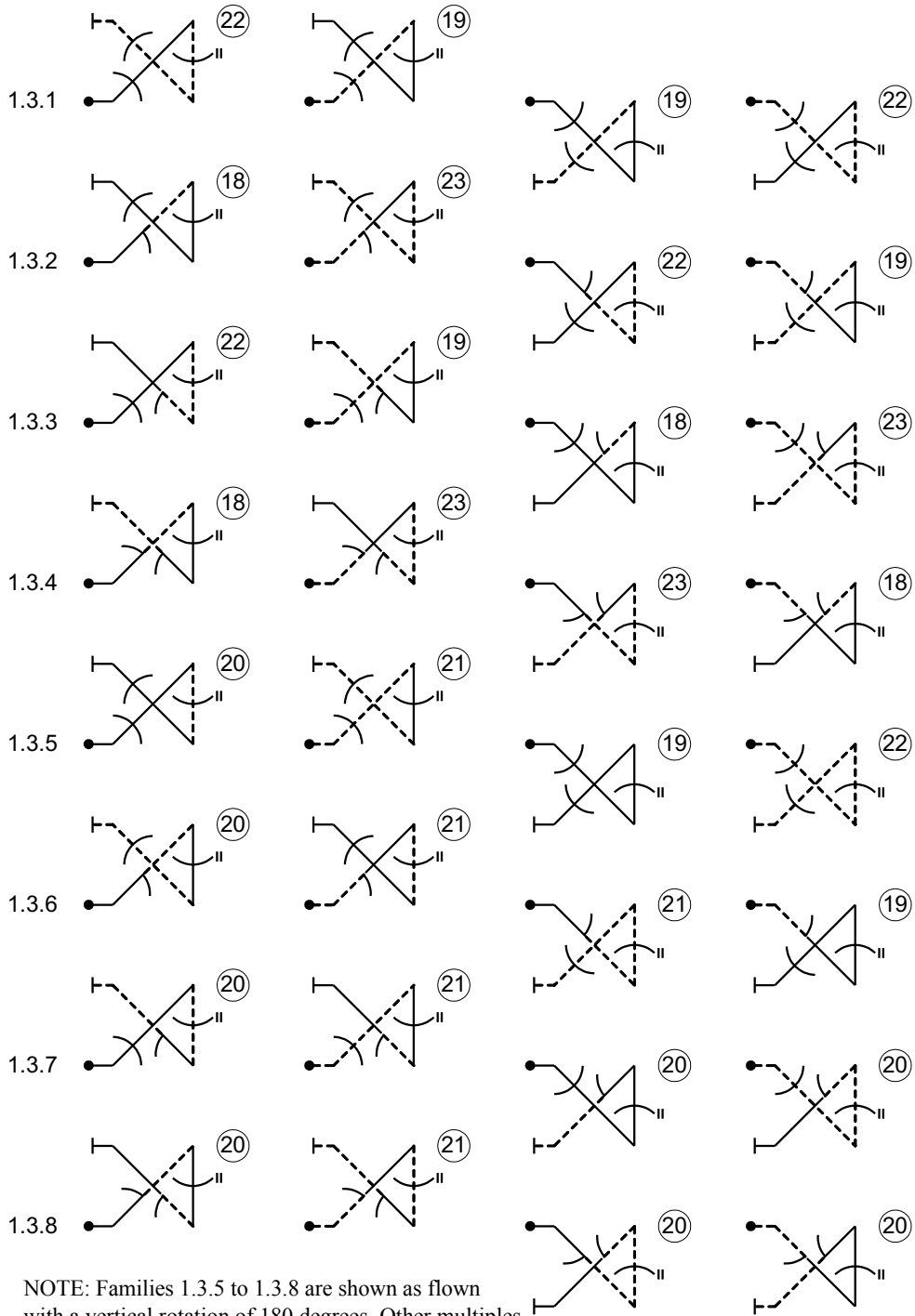

NOTE: Families 1.3.5 to 1.3.8 are shown as flown with a vertical rotation of 180 degrees. Other multiples of 90 degrees of vertical rotation are permitted.

# FAMILY 1 – LINES AND ANGLES

## ARESTI AEROBATIC CATALOGUE (CONDENSED)

### Family 1.3. (Cont.)

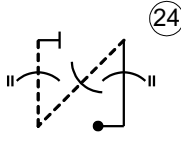
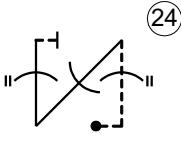
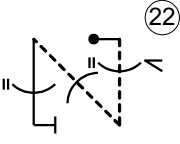
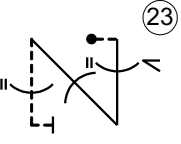
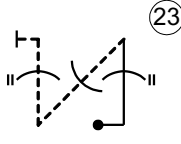
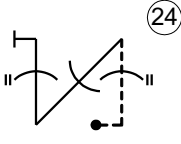
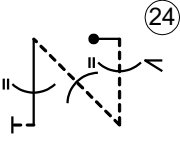
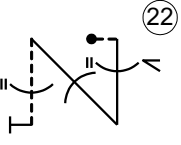
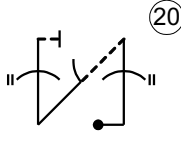
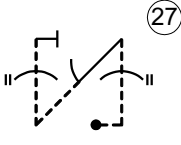
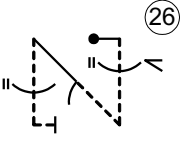
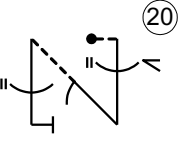
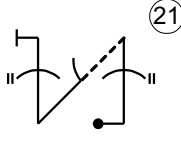
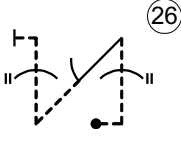
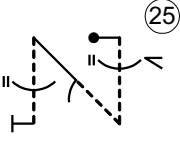
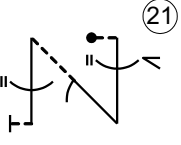
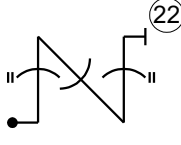
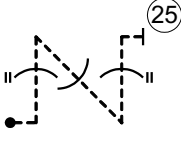
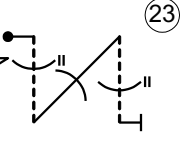
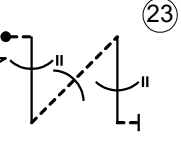
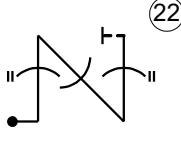
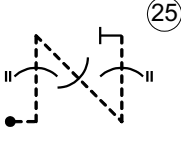
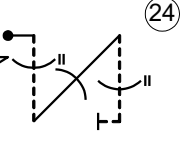
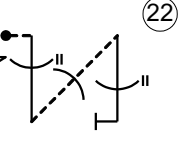
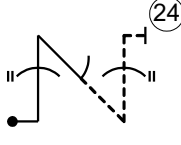
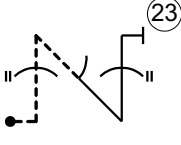
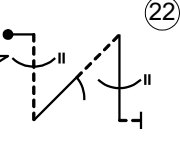
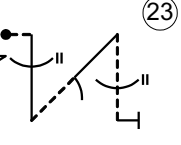
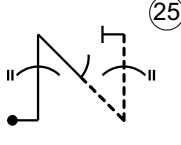
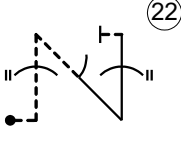
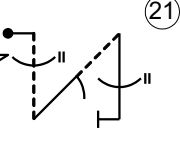
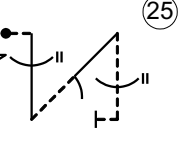
1.3.9				
1.3.10				
1.3.11				
1.3.12				
1.3.13				
1.3.14				
1.3.15				
1.3.16				

1

2

3

4

# FAMILY 2 – TURNS AND ROLLING TURNS

## ARESTI AEROBATIC CATALOGUE (CONDENSED)

### Family 2.1. 90° Turns

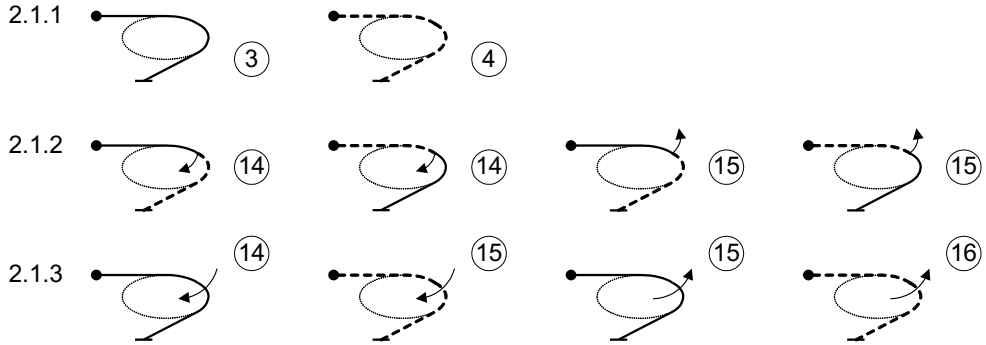

### Family 2.2. 180° Turns

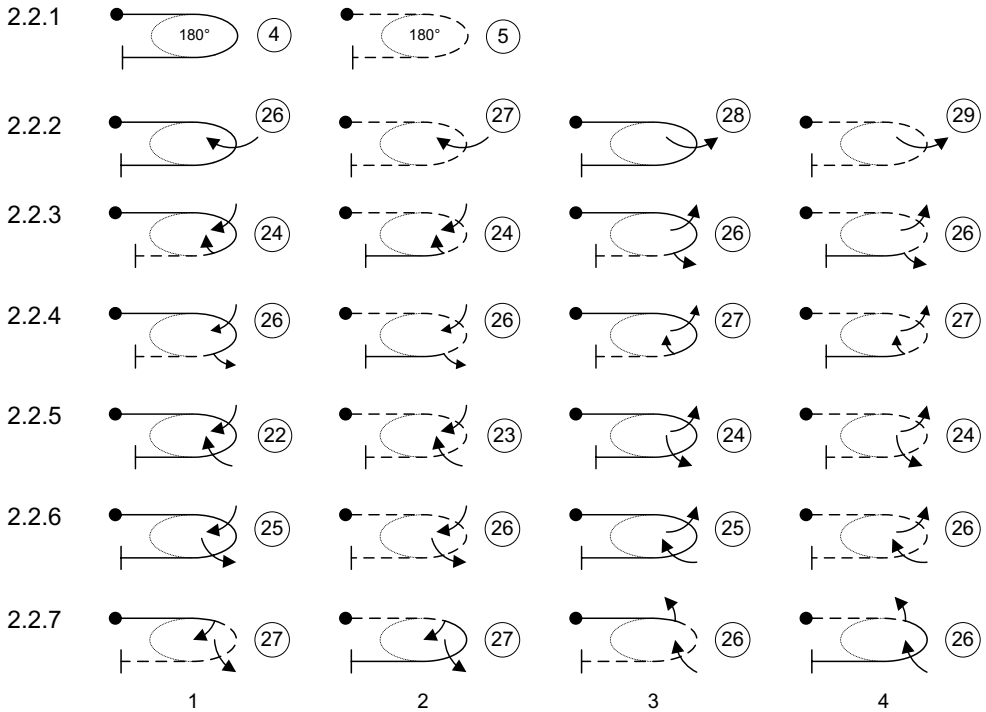

# FAMILY 2 – TURNS AND ROLLING TURNS

## ARESTI AEROBATIC CATALOGUE (CONDENSED)

### Family 2.3. 270° Turns

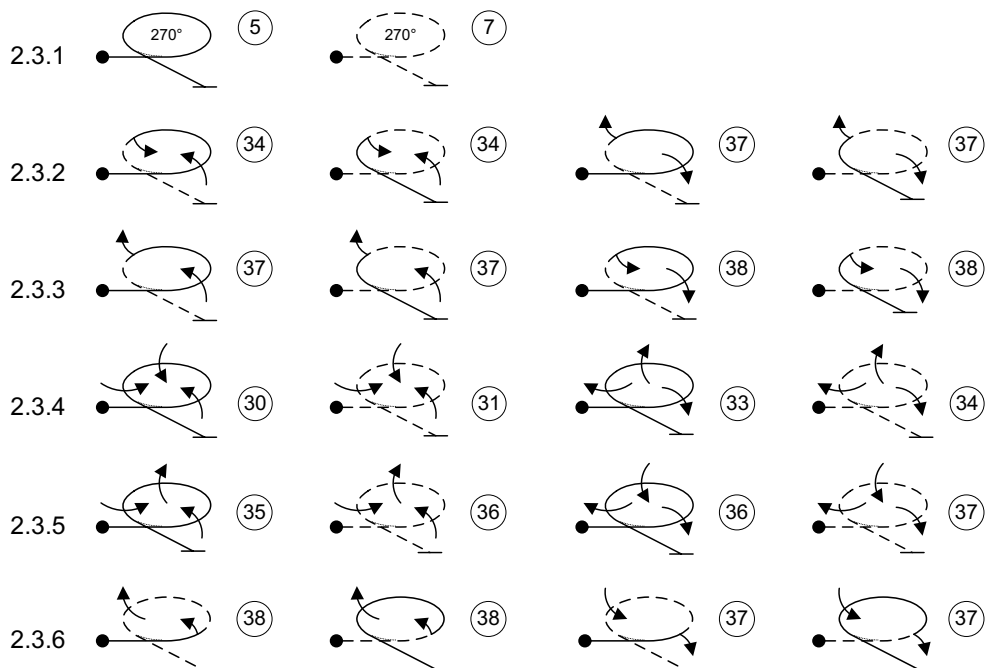

### Family 2.4. 360° Turns

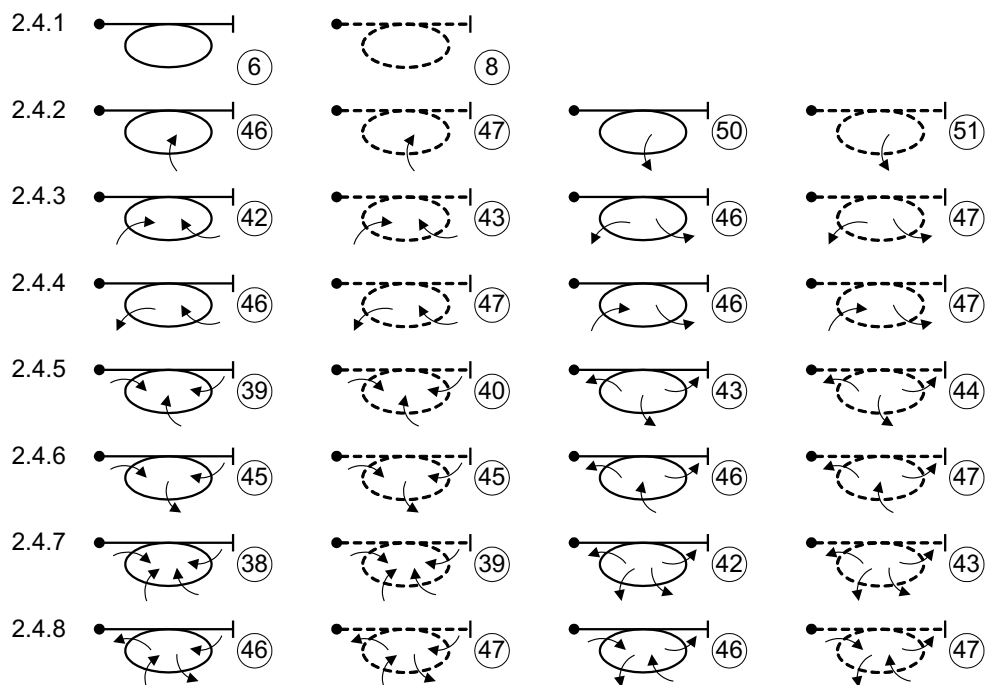

1

2

3

4



# FAMILY 3 – COMBINATIONS OF LINES

## ARESTI AEROBATIC CATALOGUE (CONDENSED)

### Family 3.3. Three Corners

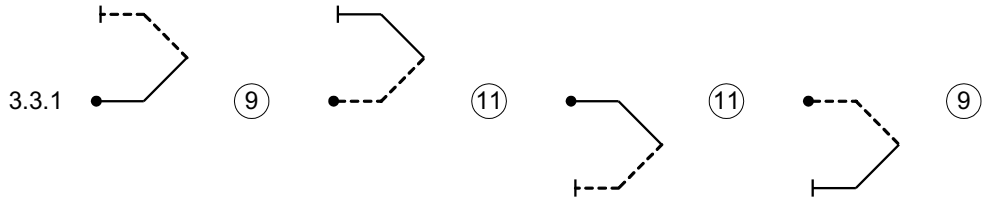

### Family 3.4. Four Corners

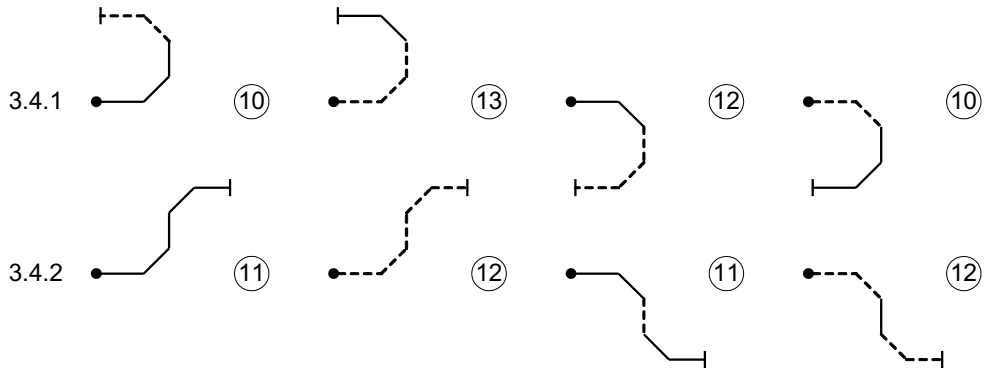

### Family 3.8. Eight Corners

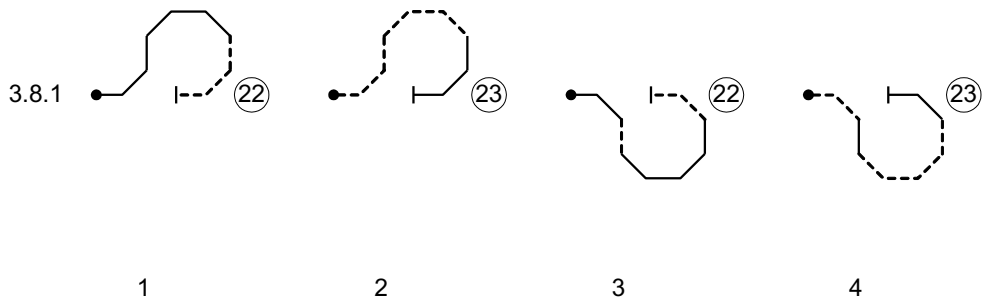

# FAMILY 5 – STALL TURNS

## ARESTI AEROBATIC CATALOGUE (CONDENSED)

### Family 5.2. Two Line Stall Turns

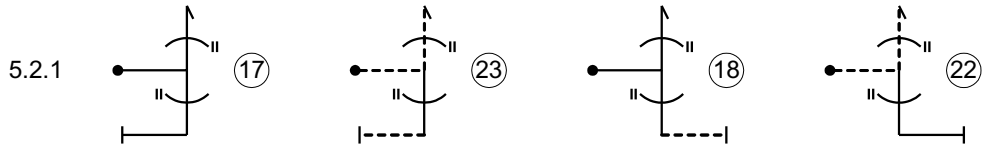

### Family 5.3. Three Line Stall Turns

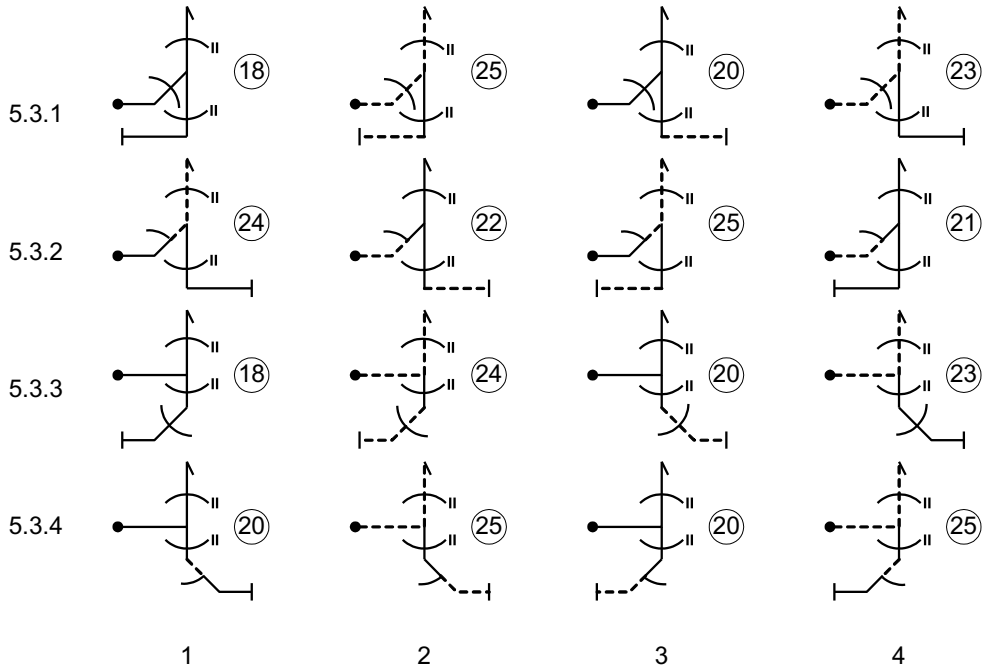

# FAMILY 5 – STALL TURNS

## ARESTI AEROBATIC CATALOGUE (CONDENSED)

### Family 5.4. Four Line Stall Turns

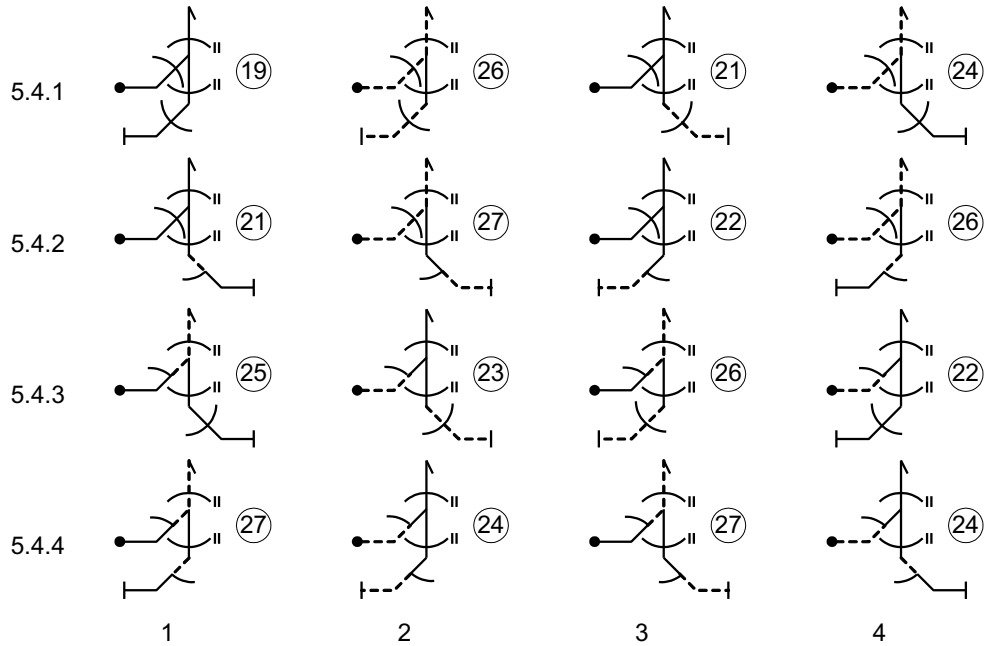

# FAMILY 6 – TAIL SLIDES

## ARESTI AEROBATIC CATALOGUE (CONDENSED)

### Family 6.2. Two Line Tail Slides

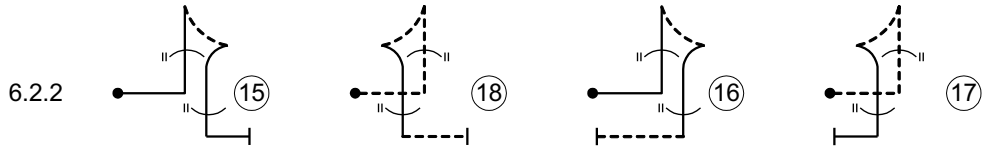
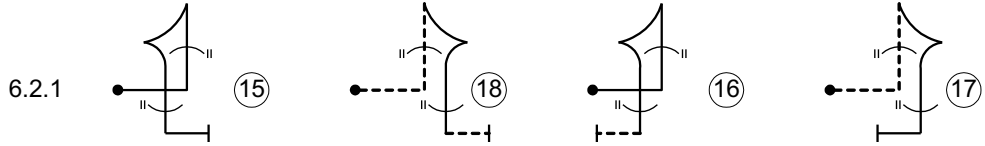

1

2

3

4

# FAMILY 7 – LOOPS AND EIGHTS

## ARESTI AEROBATIC CATALOGUE (CONDENSED)

### Family 7.2. Half Loops

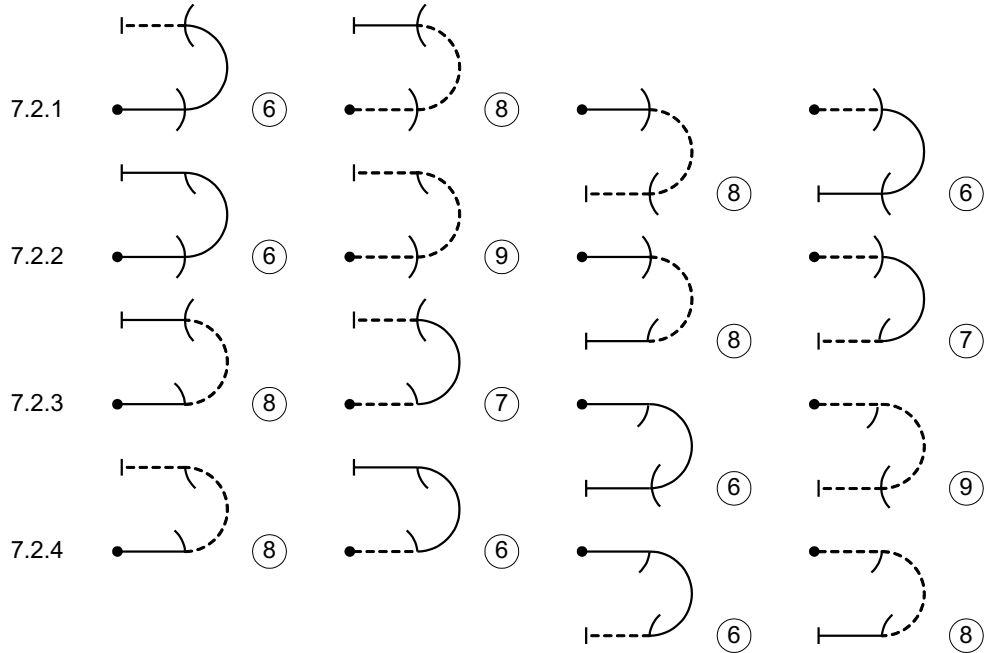

### Family 7.3. Three Quarter Loops

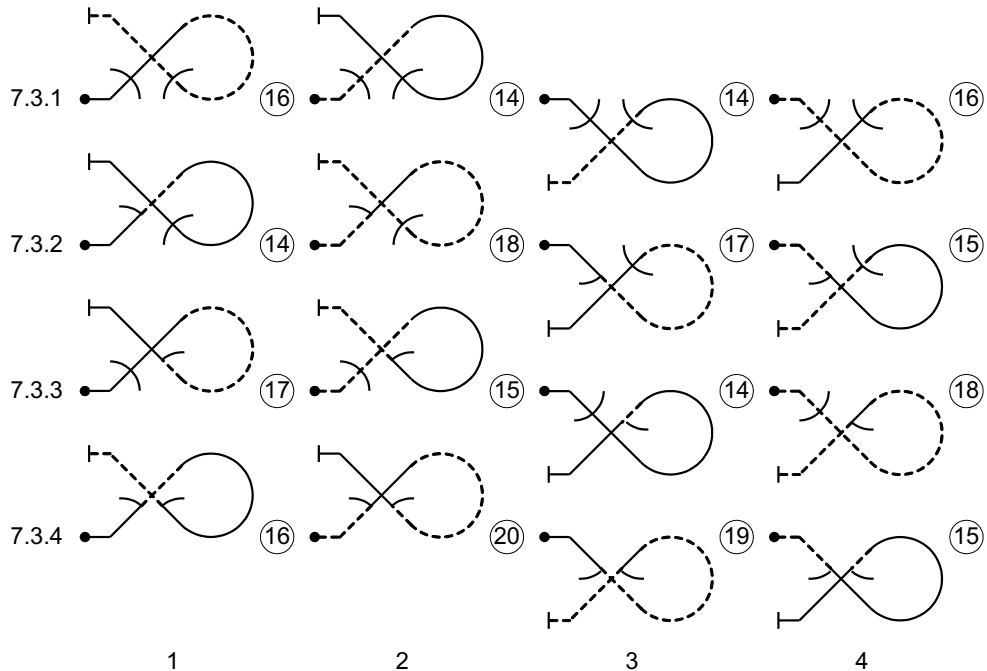

# FAMILY 7 – LOOPS AND EIGHTS

## ARESTI AEROBATIC CATALOGUE (CONDENSED)

### Family 7.4. Whole Loops

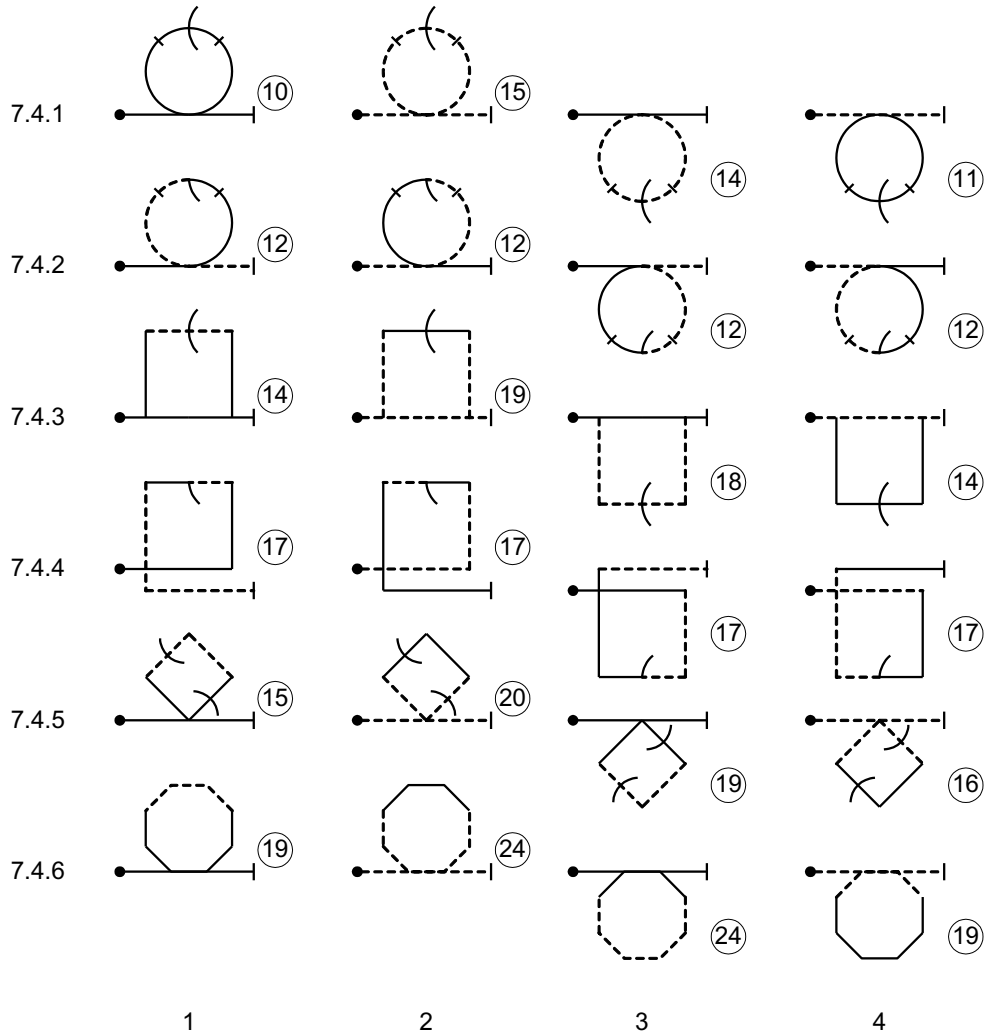

# FAMILY 7 – LOOPS AND EIGHTS

## ARESTI AEROBATIC CATALOGUE (CONDENSED)

### Family 7.4. (Cont.) Reversing Whole Loops

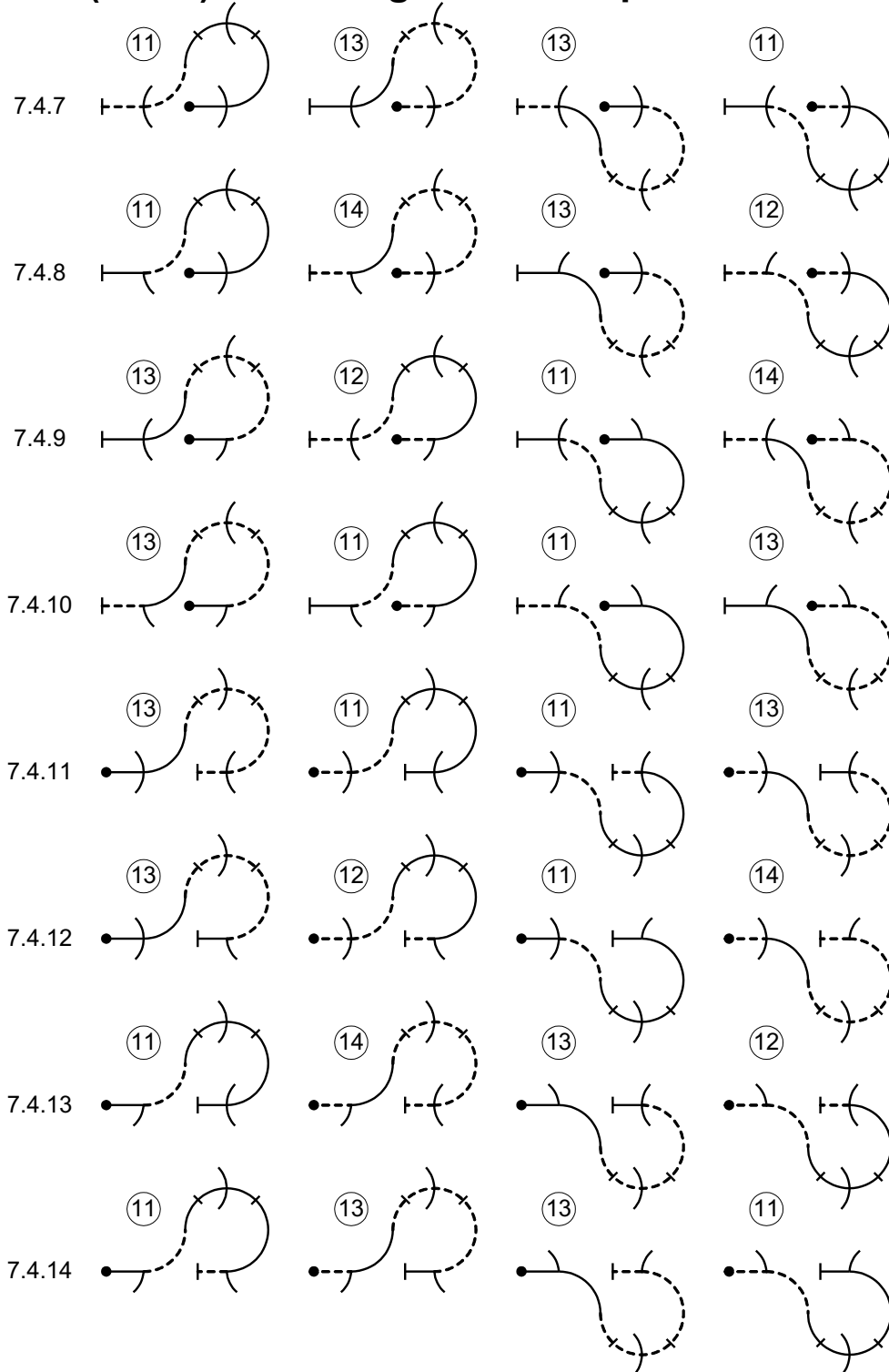

1

2

3

4

# FAMILY 7 – LOOPS AND EIGHTS

## ARESTI AEROBATIC CATALOGUE (CONDENSED)

### Family 7.5. Horizontal "S"s

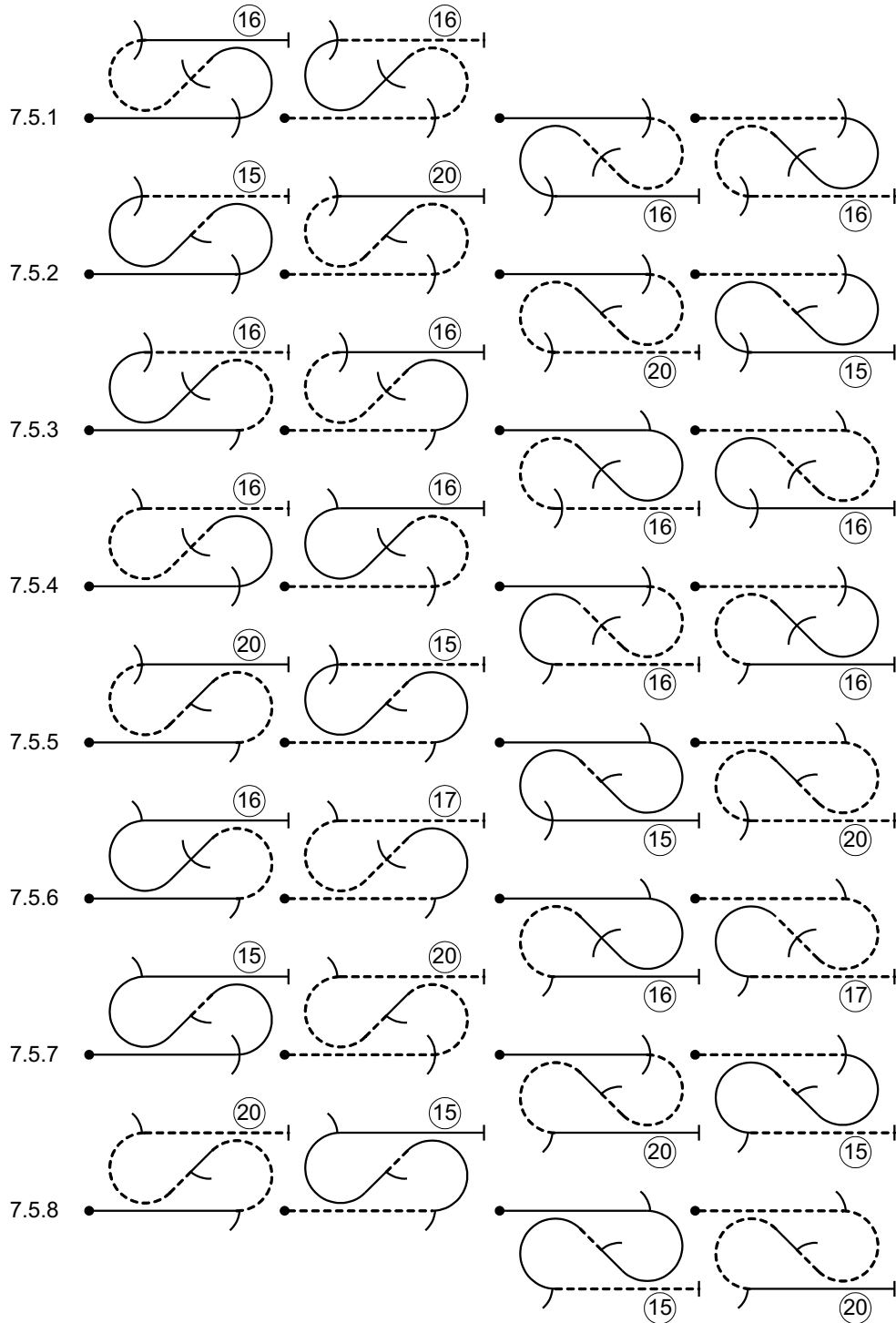

1

2

3

4



# FAMILY 7 – LOOPS AND EIGHTS

## ARESTI AEROBATIC CATALOGUE (CONDENSED)

### Family 7.5. (Cont.) Vertical “S”s

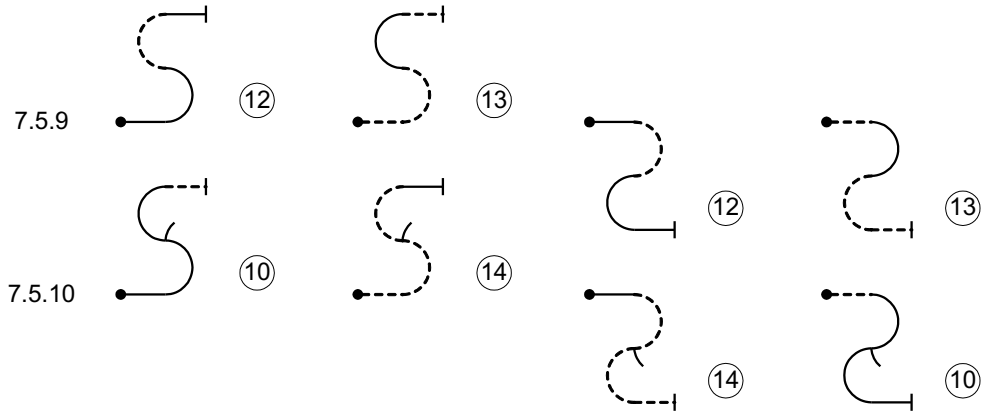

NOTE: At the sign  $\lambda$ , only half-rolls permitted.

1

2

3

4

# FAMILY 7 – LOOPS AND EIGHTS

## ARESTI AEROBATIC CATALOGUE (CONDENSED)

### Family 7.8. Horizontal "8"s

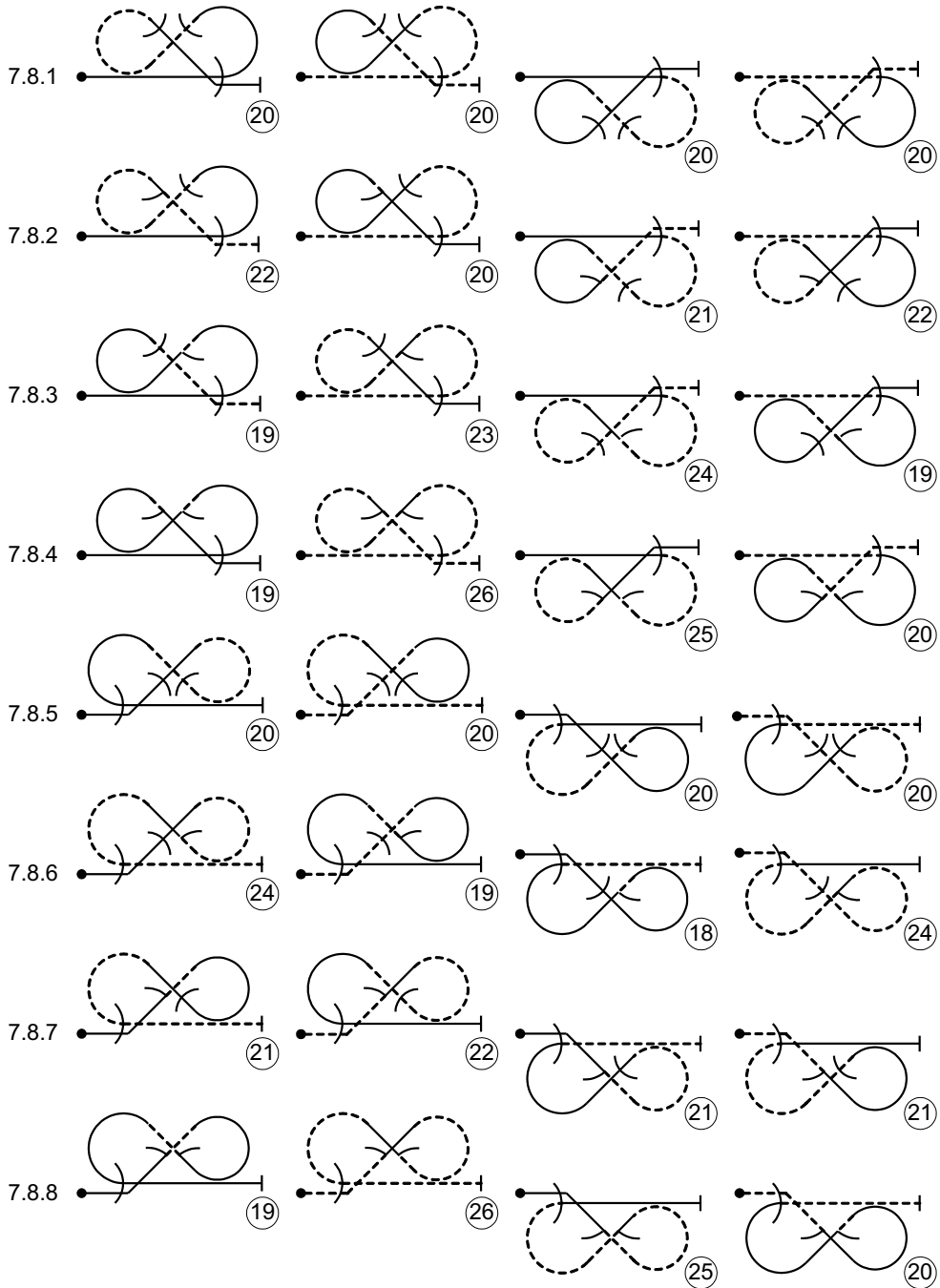

1

2

3

4

# FAMILY 7 – LOOPS AND EIGHTS

## ARESTI AEROBATIC CATALOGUE (CONDENSED)

### Family 7.8. (Cont.) Horizontal Super "8"s

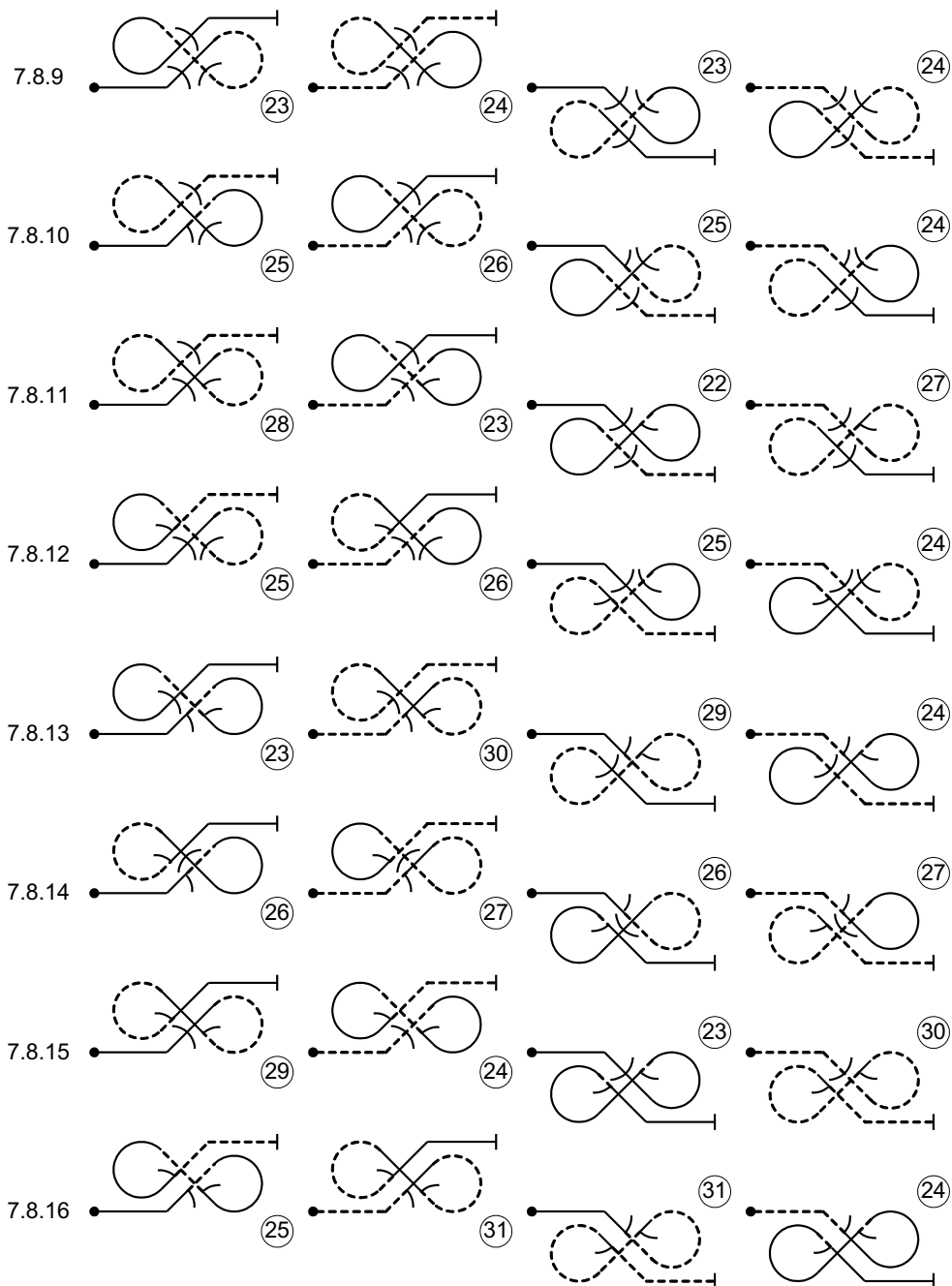

1

2

3

4

# FAMILY 7 – LOOPS AND EIGHTS

## ARESTI AEROBATIC CATALOGUE (CONDENSED)

### Family 7.8. (Cont.) Vertical “8”s

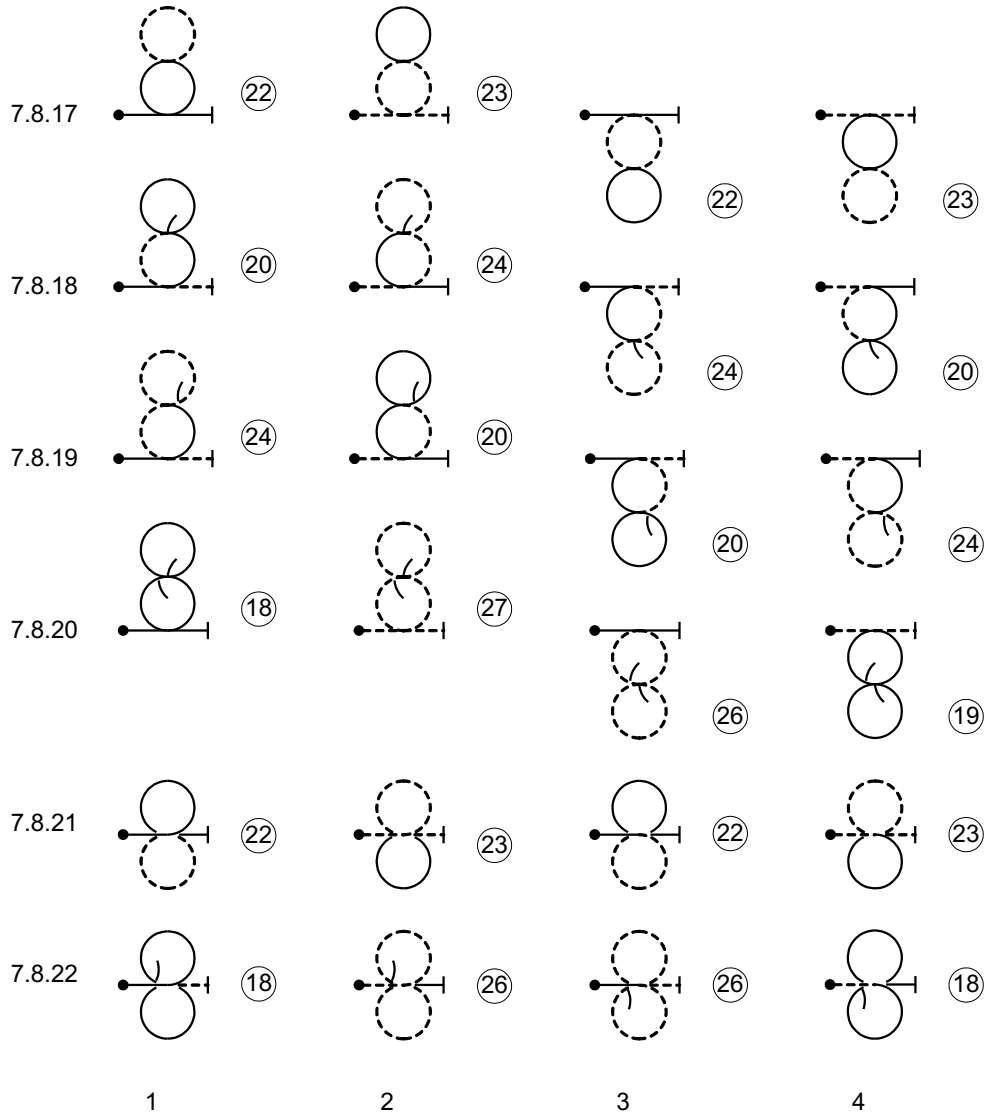

NOTE: At the sign , only half-rolls permitted.

# FAMILY 8 – COMBINATIONS OF LINES, ANGLES AND LOOPS

## ARESTI AEROBATIC CATALOGUE (CONDENSED)

### Family 8.4. Humpty Bumps

(4/8ths looping segment)

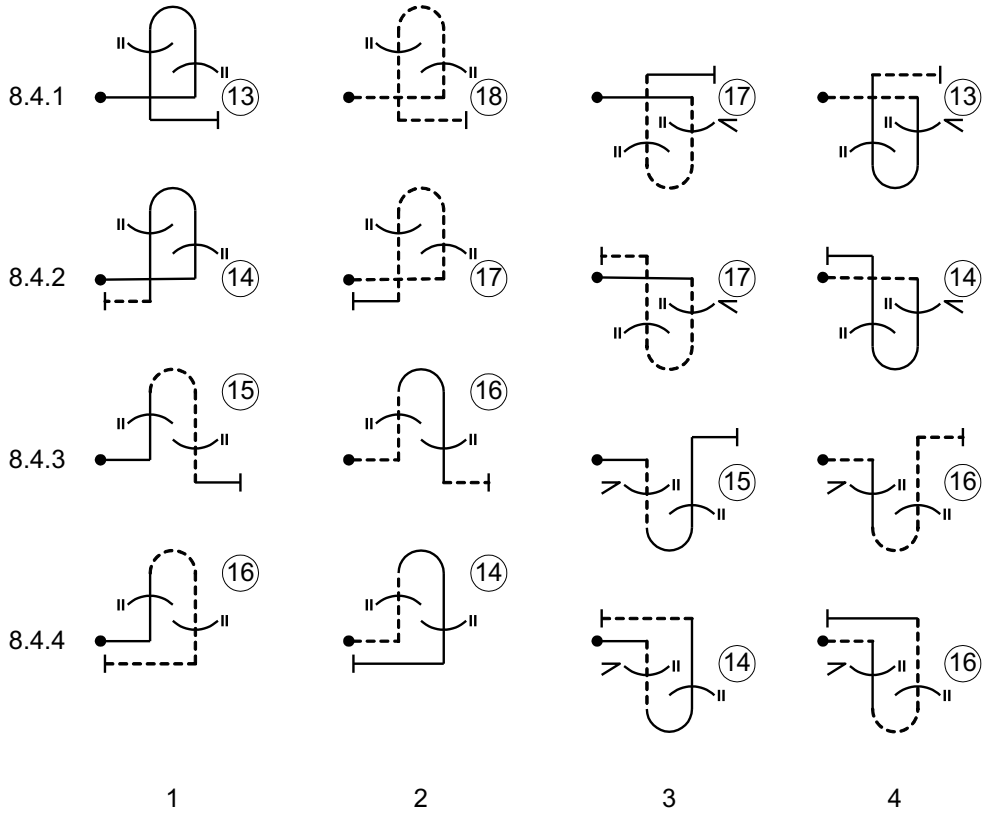

# FAMILY 8 – COMBINATIONS OF LINES, ANGLES AND LOOPS

## ARESTI AEROBATIC CATALOGUE (CONDENSED)

### Family 8.4. (Cont.) Diagonal Humpty Bumps

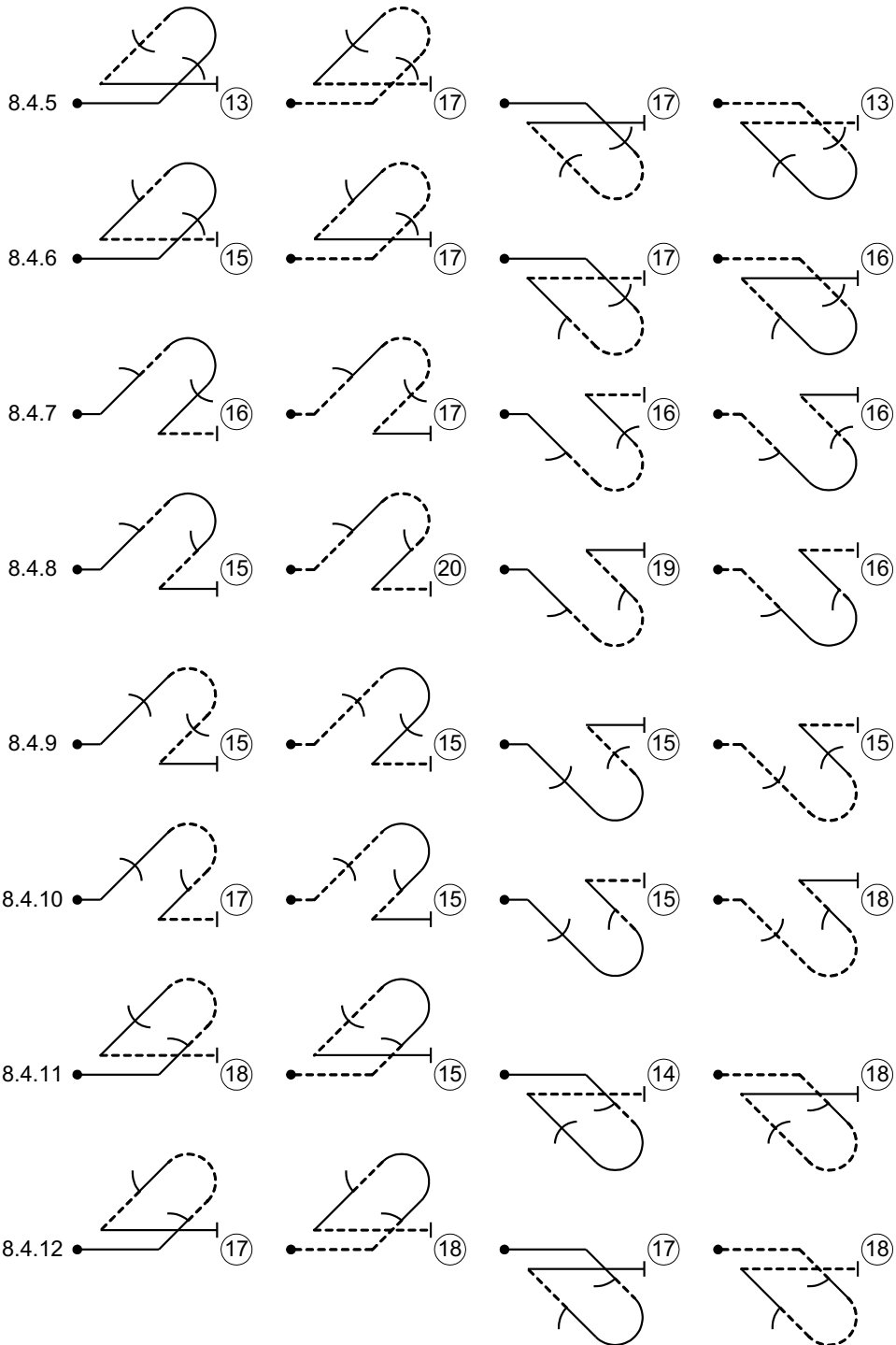

1

2

3

4

# FAMILY 8 – COMBINATIONS OF LINES, ANGLES AND LOOPS

## ARESTI AEROBATIC CATALOGUE (CONDENSED)

### Family 8.4. Diagonal Humpty Bumps (Cont.)

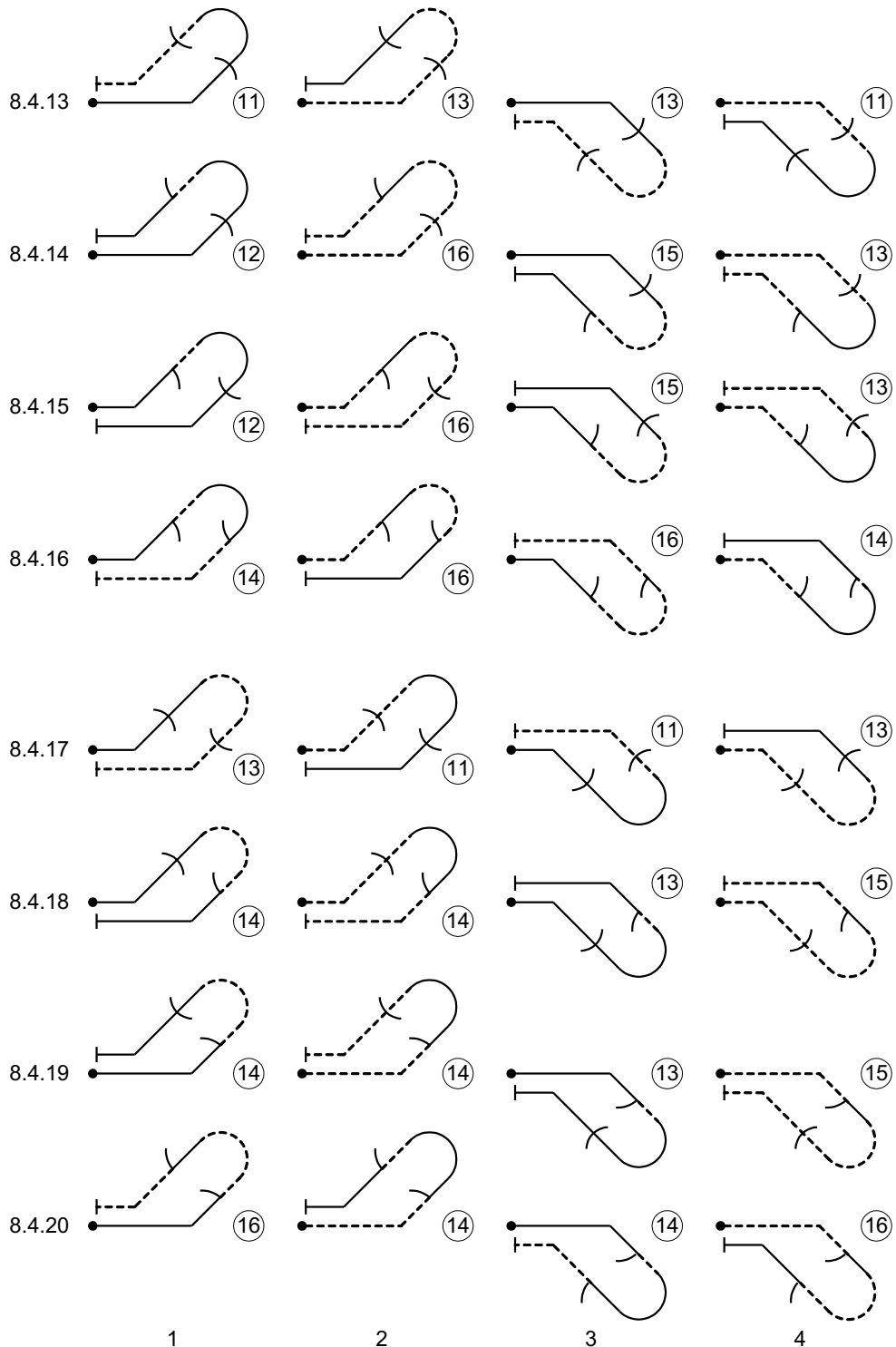

# FAMILY 8 – COMBINATIONS OF LINES, ANGLES AND LOOPS

## ARESTI AEROBATIC CATALOGUE (CONDENSED)

### Family 8.4. Diagonal Humpty Bumps (Cont.)

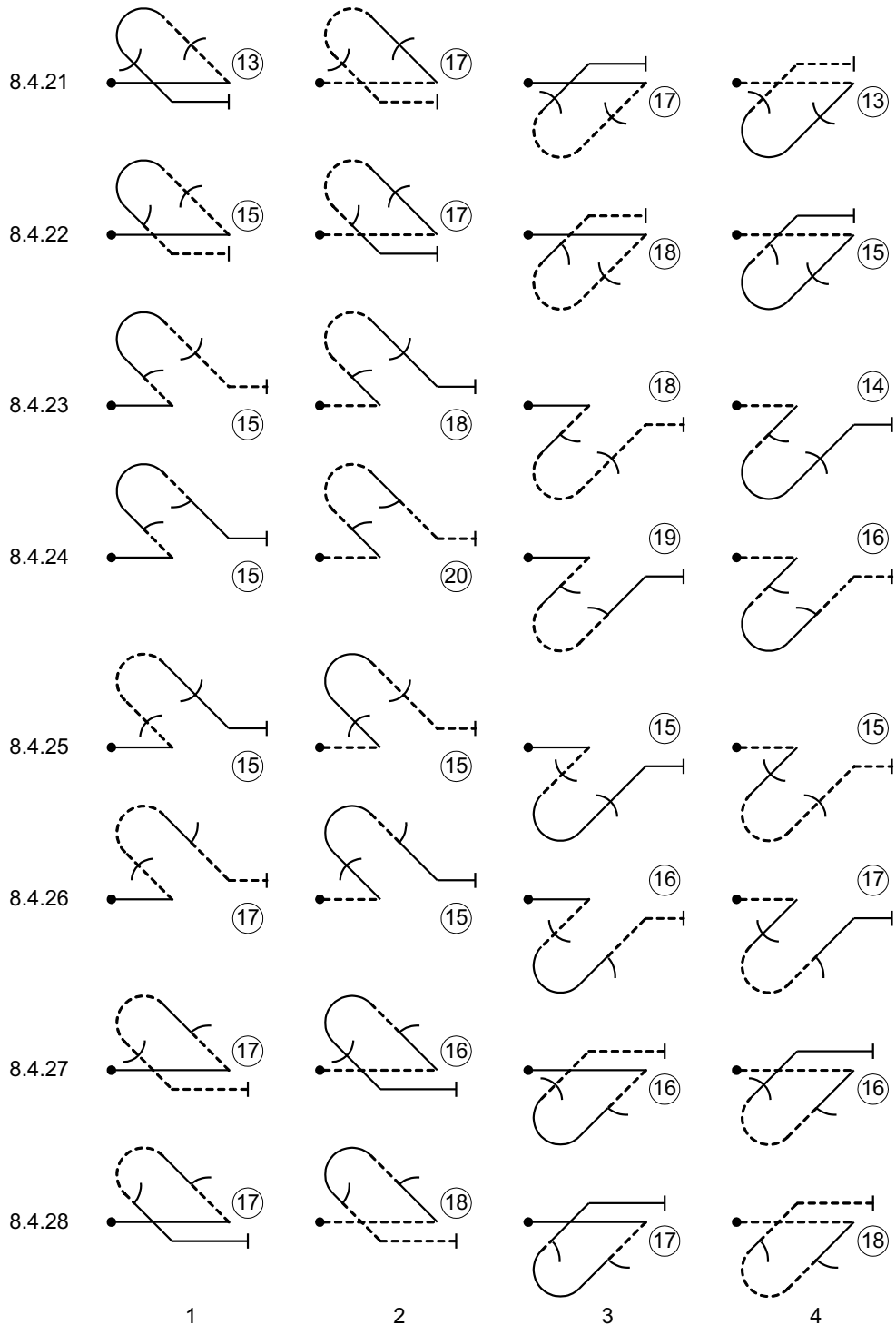



# FAMILY 8 – COMBINATIONS OF LINES, ANGLES AND LOOPS

## ARESTI AEROBATIC CATALOGUE (CONDENSED)

### Family 8.5. Half Cubans

(5/8ths looping segment)

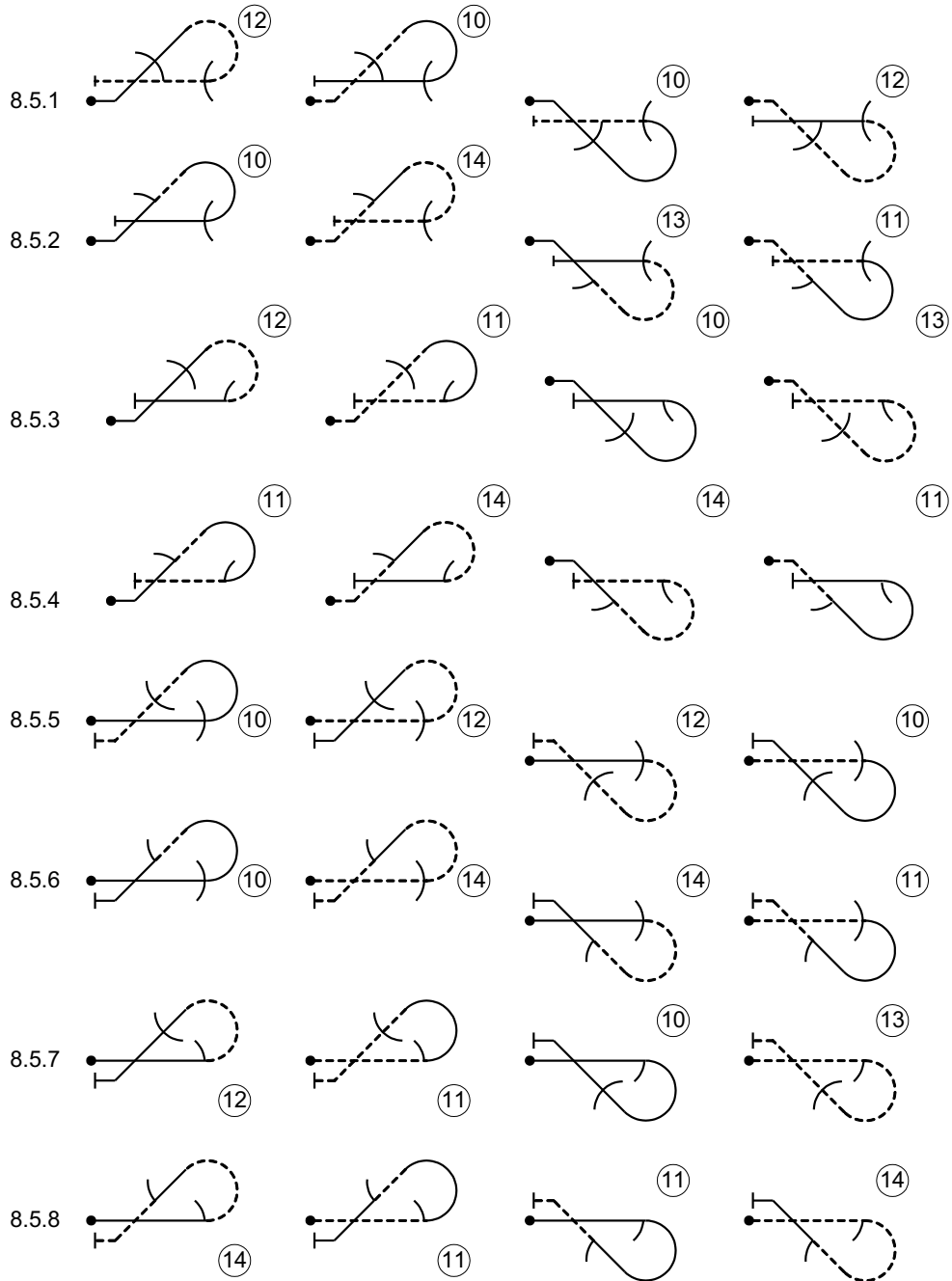

1

2

3

4

# FAMILY 8 – COMBINATIONS OF LINES, ANGLES AND LOOPS

## ARESTI AEROBATIC CATALOGUE (CONDENSED)

### Family 8.5. (Cont.) Vertical 5/8ths Loops

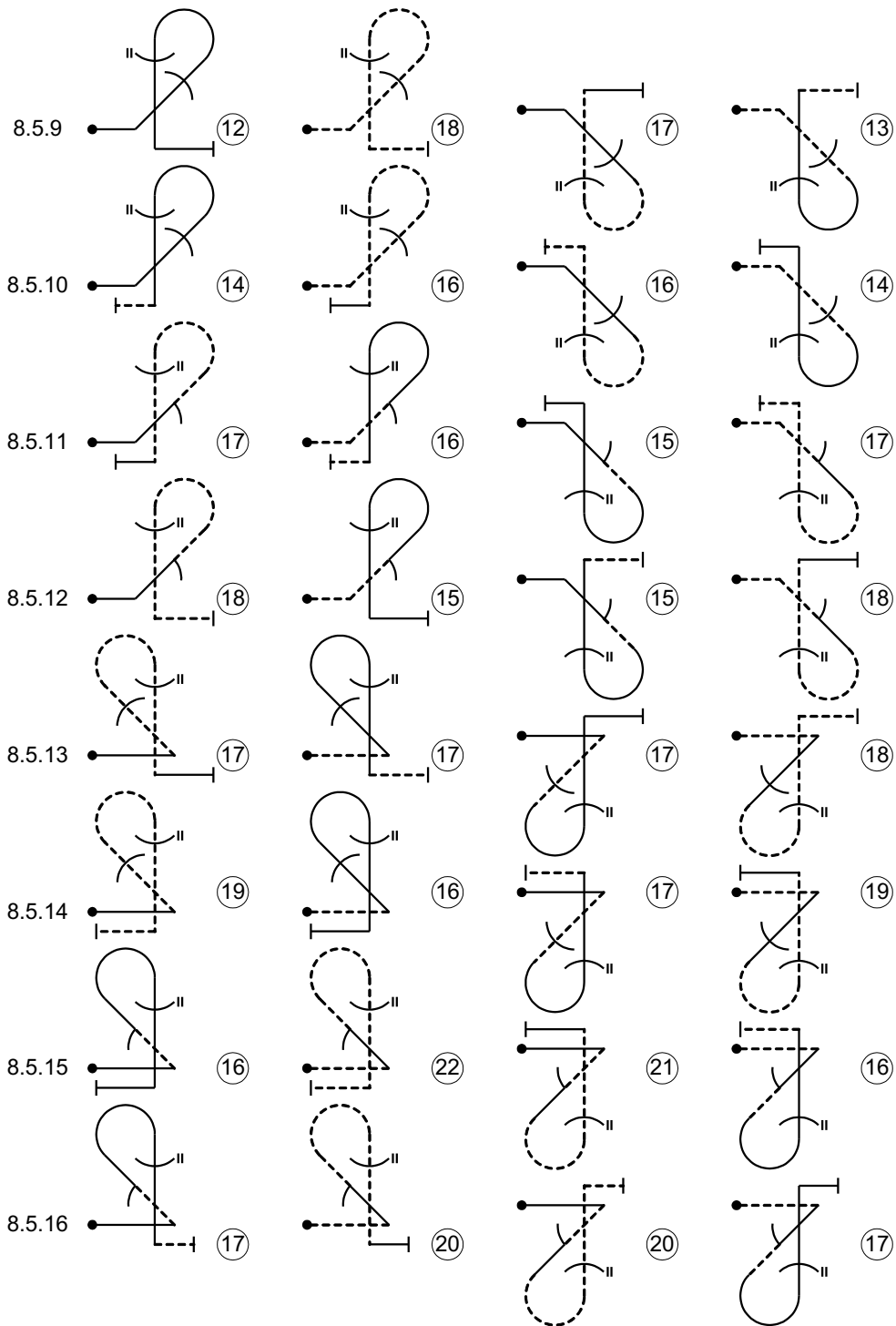

1

2

3

4

# FAMILY 8 – COMBINATIONS OF LINES, ANGLES AND LOOPS

## ARESTI AEROBATIC CATALOGUE (CONDENSED)

### Family 8.5. (Cont.) Vertical 5/8ths Loops

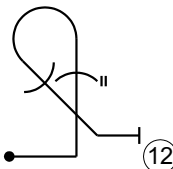
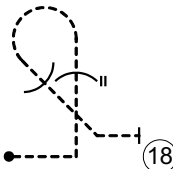
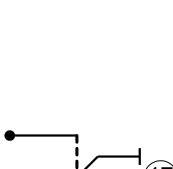
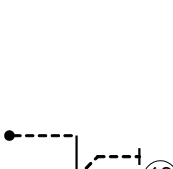
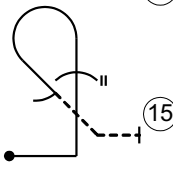
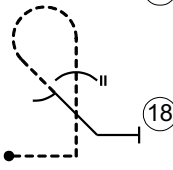
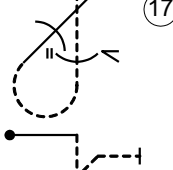
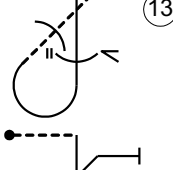
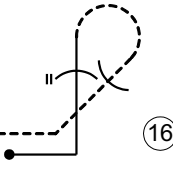
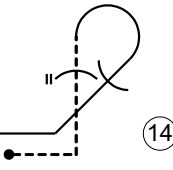
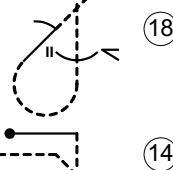
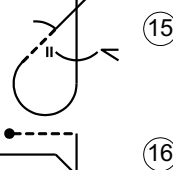
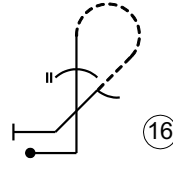
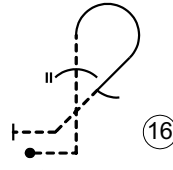
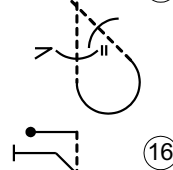
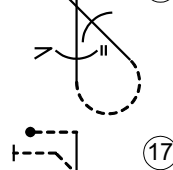
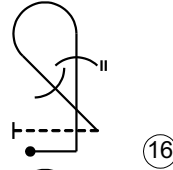
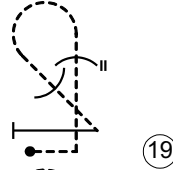
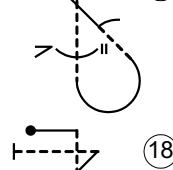
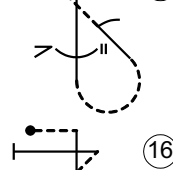
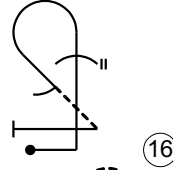
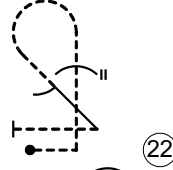
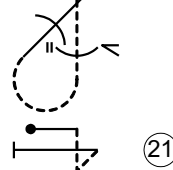
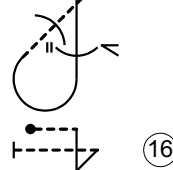
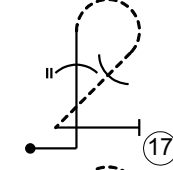
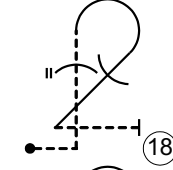
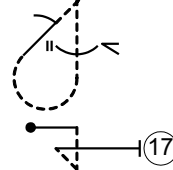
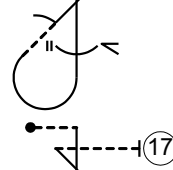
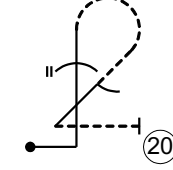
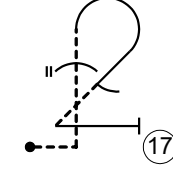
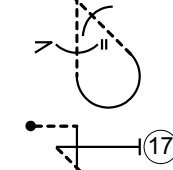
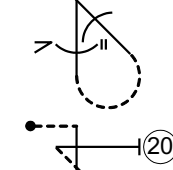
8.5.17				
8.5.18				
8.5.19				
8.5.20				
8.5.21				
8.5.22				
8.5.23				
8.5.24				
	1	2	3	4

# FAMILY 8 – COMBINATIONS OF LINES, ANGLES AND LOOPS

## ARESTI AEROBATIC CATALOGUE (CONDENSED)

### Family 8.6. "P" Loops

(6/8ths looping segment)

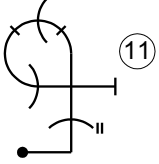
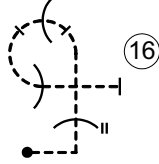
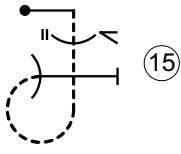
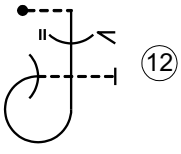
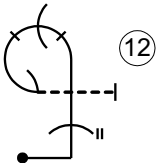
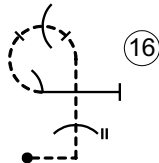
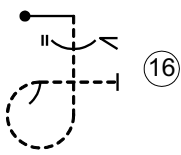
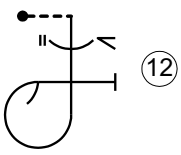
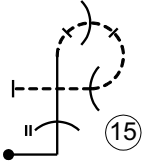
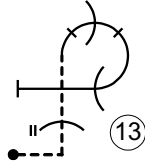
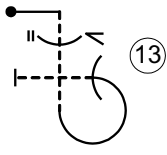
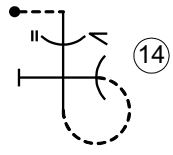
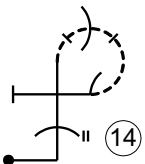
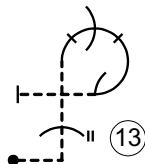
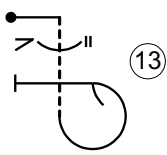
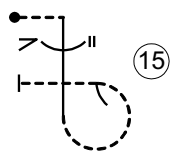
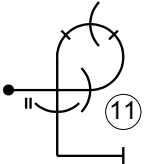
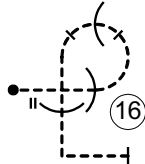
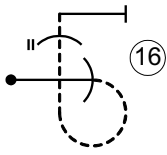
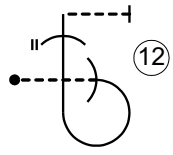
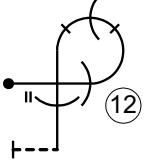
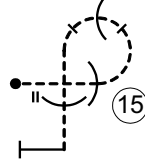
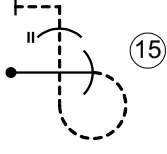
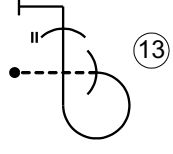
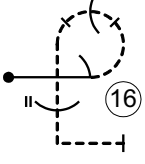
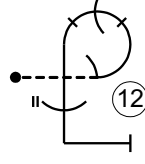
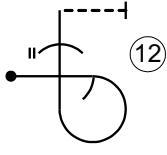
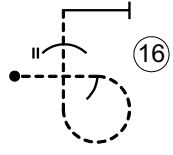
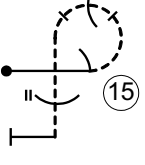
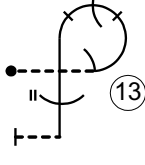
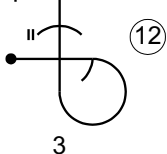
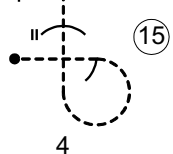
8.6.1				
8.6.2				
8.6.3				
8.6.4				
8.6.5				
8.6.6				
8.6.7				
8.6.8				
	1	2	3	4

# FAMILY 8 – COMBINATIONS OF LINES, ANGLES AND LOOPS

## ARESTI AEROBATIC CATALOGUE (CONDENSED)

### Family 8.6. (Cont.) Reversing “P” Loops

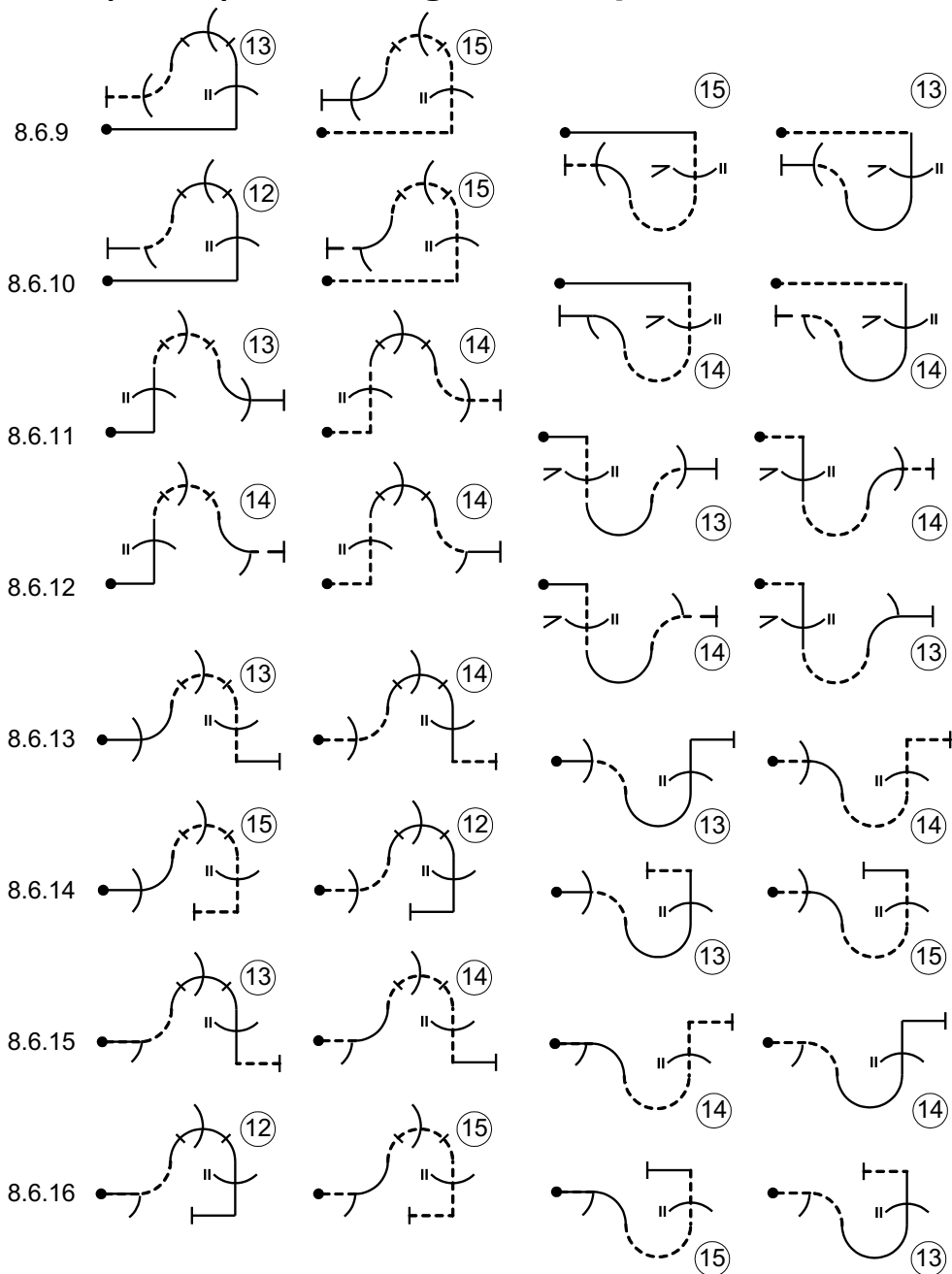

1

2

3

4

# FAMILY 8 – COMBINATIONS OF LINES, ANGLES AND LOOPS

## ARESTI AEROBATIC CATALOGUE (CONDENSED)

### Family 8.6. (Cont.) “P” Loops

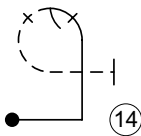
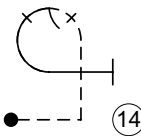
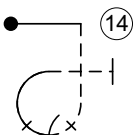
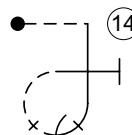
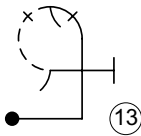
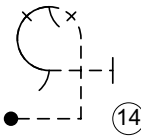
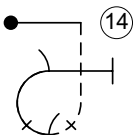
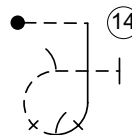
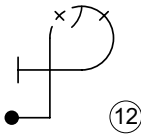
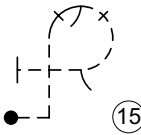
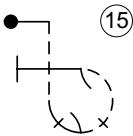
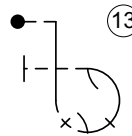
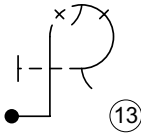
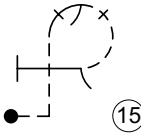
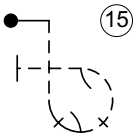
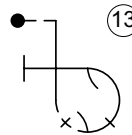
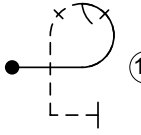
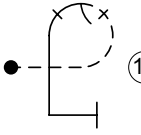
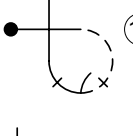
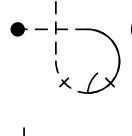
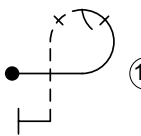
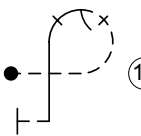
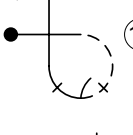
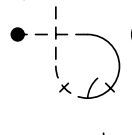
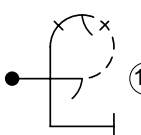
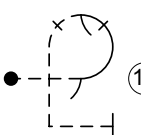
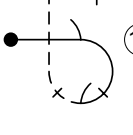
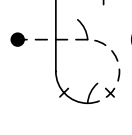
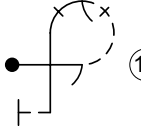
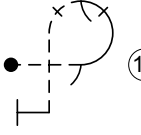
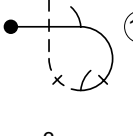
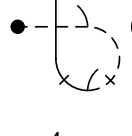
8.6.17				
8.6.18				
8.6.19				
8.6.20				
8.6.21				
8.6.22				
8.6.23				
8.6.24				
	1	2	3	4

# FAMILY 8 – COMBINATIONS OF LINES, ANGLES AND LOOPS

## ARESTI AEROBATIC CATALOGUE (CONDENSED)

### Family 8.7. “Q” Loops

(7/8ths looping segment)

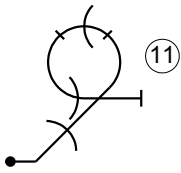
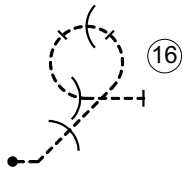
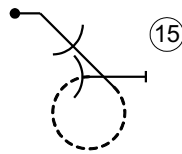
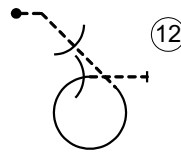
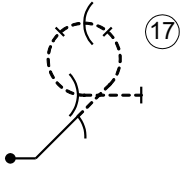
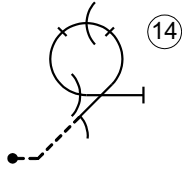
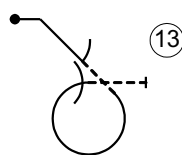
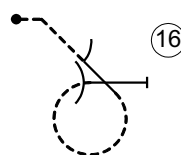
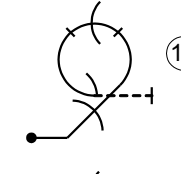
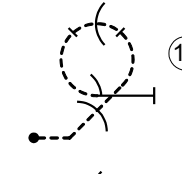
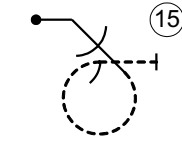
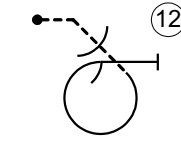
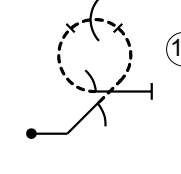
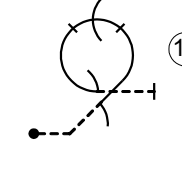
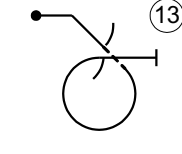
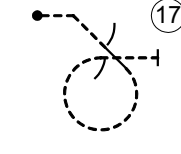
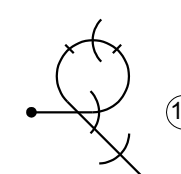
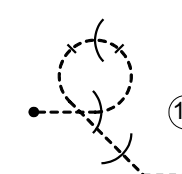
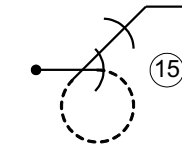
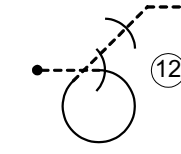
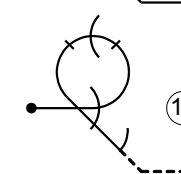
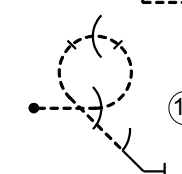
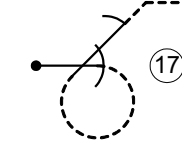
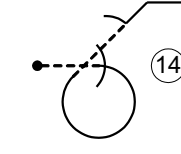
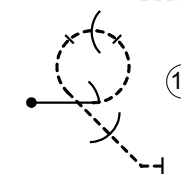
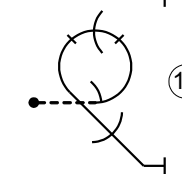
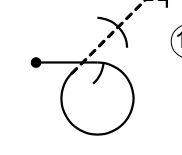
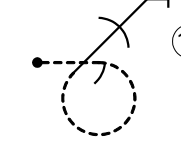
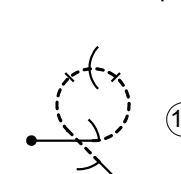
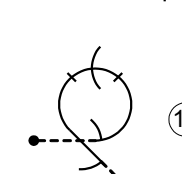
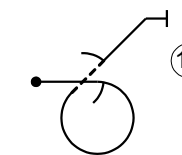
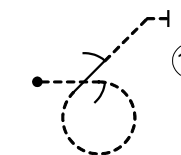
8.7.1				
8.7.2				
8.7.3				
8.7.4				
8.7.5				
8.7.6				
8.7.7				
8.7.8				
	1	2	3	4

ARESTI AEROBATIC CATALOGUE (CONDENSED)

Family 8.8. Double Humpty Bumps

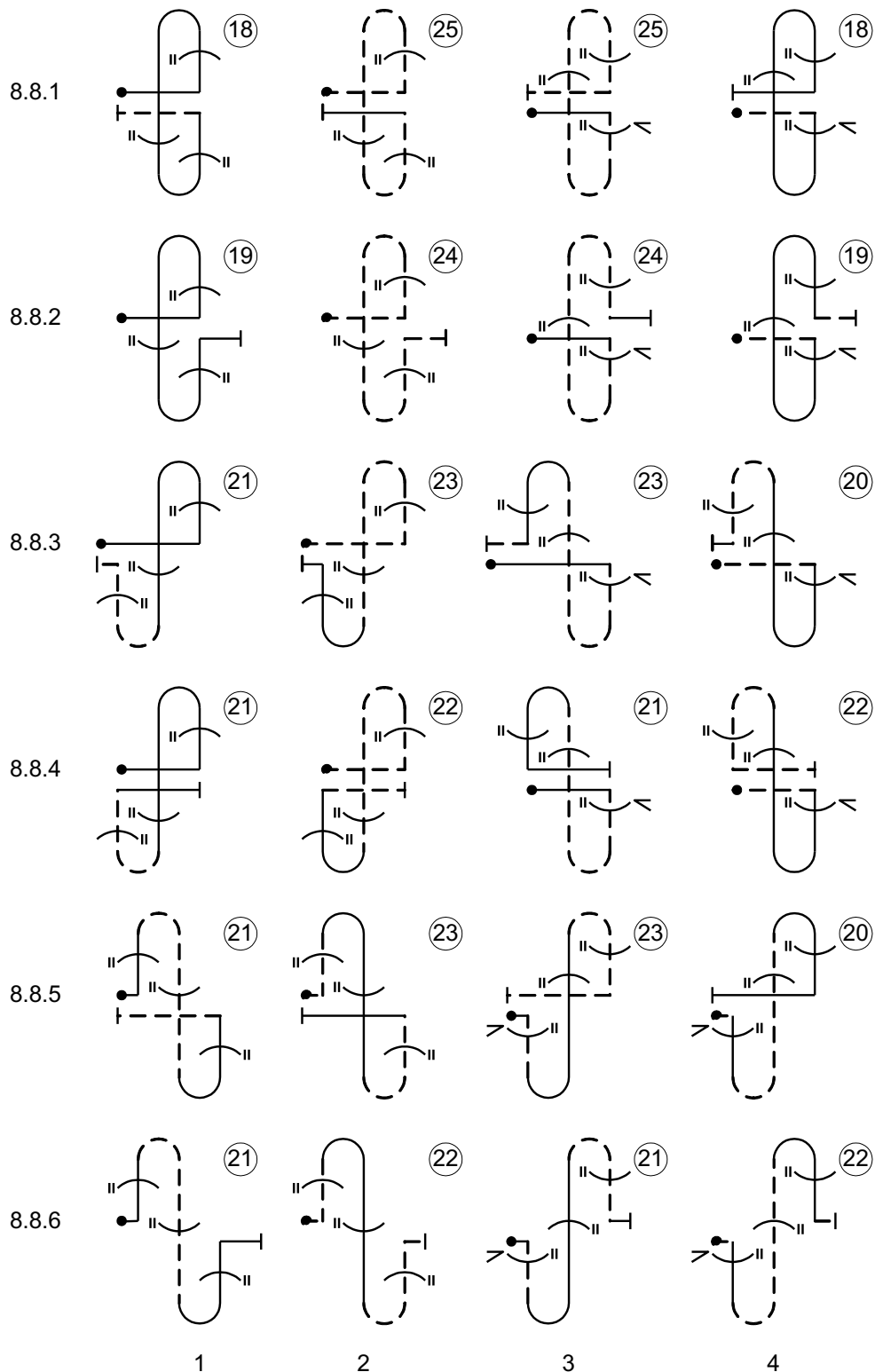



# FAMILY 8 – COMBINATIONS OF LINES, ANGLES AND LOOPS

## ARESTI AEROBATIC CATALOGUE (CONDENSED)

### Family 8.8. Double Humpty Bumps (Cont.)

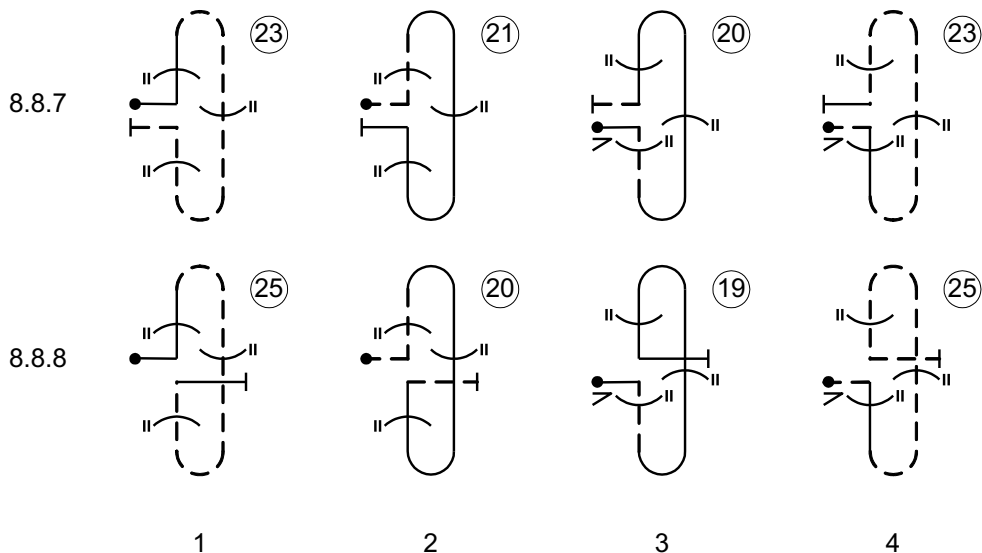

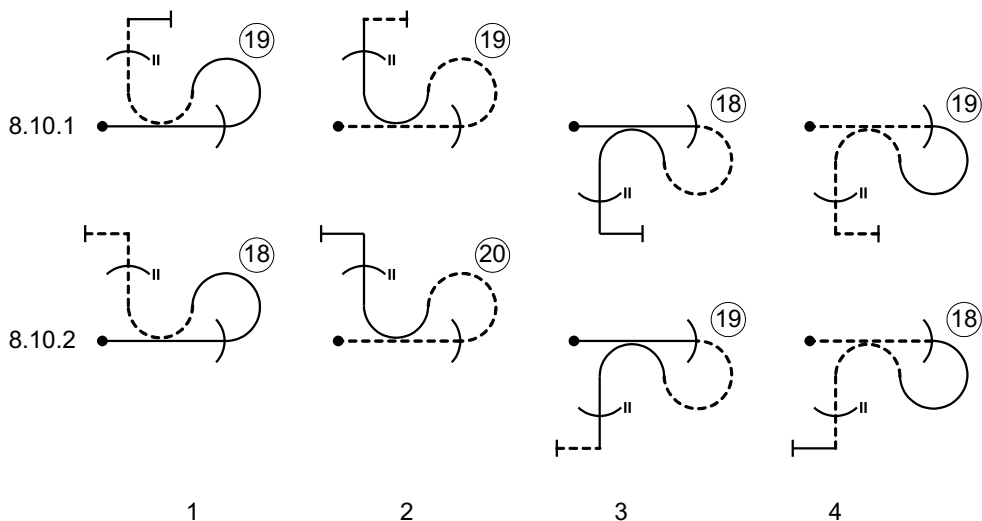

### Family 8.10 Reversing 1 ¼ Loops



# FAMILY 9 – ROLLS AND SPINS

## ARESTI AEROBATIC CATALOGUE (CONDENSED)

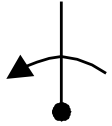
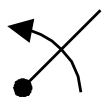
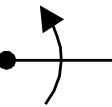
### Family 9.1. (Aileron Rolls)

9.1		$\frac{1}{4}$	$\frac{1}{2}$	$\frac{3}{4}$	1	$1\frac{1}{4}$	$1\frac{1}{2}$	$1\frac{3}{4}$	2
1		6	8	10	12	14	15	17	18
2		4	6	8	10	11	12	14	15
3		2	4	6	8	9	10	11	12
4		2	4	6	8	9	10	11	12
5		2	4	6	8	9	10	11	12
		<b>1</b>	<b>2</b>	<b>3</b>	<b>4</b>	<b>5</b>	<b>6</b>	<b>7</b>	<b>8</b>

# FAMILY 9 – ROLLS AND SPINS

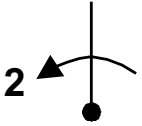
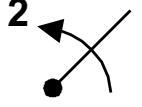
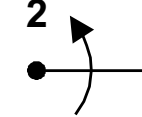
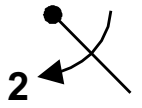
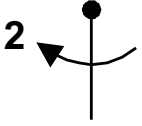

## ARESTI AEROBATIC CATALOGUE (CONDENSED)

### Family 9.2. (2-Point Rolls)

9.2					1		1½		2
1					13		17		21
2					11		14		18
3					9		12		15
4					9		12		15
5					9		12		15
		1	2	3	4	5	6	7	8

**FAMILY 9 – ROLLS AND SPINS**  
**ARESTI AEROBATIC CATALOGUE (CONDENSED)**

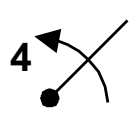
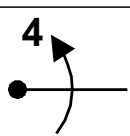



**Family 9.4. (4-Point Rolls)**

9.4			$\frac{1}{2}$	$\frac{3}{4}$	1	$1\frac{1}{4}$	$1\frac{1}{2}$	$1\frac{3}{4}$	2
		1			9	12	15	18	20
2			7	10	13	15	17	20	22
3			5	8	11	13	15	17	19
4			5	8	11	13	15	17	19
5			5	8	11	13	15	17	19
		<b>1</b>	<b>2</b>	<b>3</b>	<b>4</b>	<b>5</b>	<b>6</b>	<b>7</b>	<b>8</b>

# FAMILY 9 – ROLLS AND SPINS

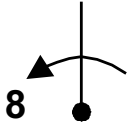
## ARESTI AEROBATIC CATALOGUE (CONDENSED)

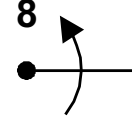

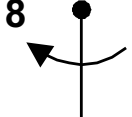



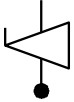

### Family 9.8. (8-Point Rolls)

9.8		$\frac{1}{4}$	$\frac{1}{2}$	$\frac{3}{4}$	1	$1\frac{1}{4}$	$1\frac{1}{2}$	$1\frac{3}{4}$	2
1		7	11	15	19	23	26	30	33
2		5	9	13	17	20	23	27	30
3		3	7	11	15	18	21	24	27
4		3	7	11	15	18	21	24	27
5		3	7	11	15	18	21	24	27
		1	2	3	4	5	6	7	8

# FAMILY 9 – ROLLS AND SPINS

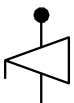
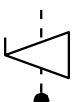
## ARESTI AEROBATIC CATALOGUE (CONDENSED)



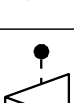







### Family 9.9. (Positive Flick Rolls)

9.9			$\frac{1}{2}$	$\frac{3}{4}$	1	$1\frac{1}{4}$	$1\frac{1}{2}$	$1\frac{3}{4}$	2
1			15	15	15	17	19	21	23
2			13	13	13	15	16	18	20
3			11	11	11	13	14	16	17
4			11	11	11	13	14	16	17
5			11	11	11	13	14	16	17
6			17	17	17	20	22	24	26
7			15	15	15	17	19	21	23
8			13	13	13	15	16	18	20
9			13	13	13	15	16	18	20
10			13	13	13	15	16	18	20
		<b>1</b>	<b>2</b>	<b>3</b>	<b>4</b>	<b>5</b>	<b>6</b>	<b>7</b>	<b>8</b>

# FAMILY 9 – ROLLS AND SPINS





## ARESTI AEROBATIC CATALOGUE (CONDENSED)

### Family 9.10. (Negative Flick Rolls)



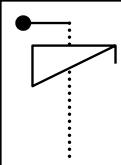

9.10			$\frac{1}{2}$	$\frac{3}{4}$	1	$1\frac{1}{4}$	$1\frac{1}{2}$	$1\frac{3}{4}$	2
1			17	17	17	20	22	24	26
2			15	15	15	17	19	21	23
3			13	13	13	15	16	18	20
4			13	13	13	15	16	18	20
5			13	13	13	15	16	18	20
6			19	19	19	22	24	27	29
7			17	17	17	19	21	24	26
8			15	15	15	17	19	21	23
9			15	15	15	17	19	21	23
10			15	15	15	17	19	21	23
		<b>1</b>	<b>2</b>	<b>3</b>	<b>4</b>	<b>5</b>	<b>6</b>	<b>7</b>	<b>8</b>

**FAMILY 9 – ROLLS AND SPINS**  
**ARESTI AEROBATIC CATALOGUE (CONDENSED)**

**Family 9.11. (Positive Spins)**

								
			<b>1</b>	<b>1¼</b>	<b>1½</b>	<b>1¾</b>	<b>2</b>	
<b>1</b>		<b>Upright Entry Line</b>			<b>5</b>	<b>4</b>	<b>3</b>	<b>3</b>
			<b>4</b>	<b>5</b>	<b>6</b>	<b>7</b>	<b>8</b>	

**Family 9.12. (Negative Spins)**

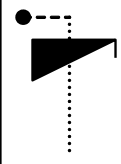
								
			<b>1</b>	<b>1¼</b>	<b>1½</b>	<b>1¾</b>	<b>2</b>	
<b>1</b>		<b>Inverted Entry Line</b>			<b>7</b>	<b>6</b>	<b>5</b>	<b>5</b>
			<b>4</b>	<b>5</b>	<b>6</b>	<b>7</b>	<b>8</b>	